

TECHNICAL MANUAL

**OPERATOR'S AND ORGANIZATIONAL
MAINTENANCE MANUAL**

**TEST FACILITY SET AN/GRM-95(V)2
(NSN 6625-01-104-8926)**

HEADQUARTERS, DEPARTMENT OF THE ARMY

9 MARCH 1983

**OPERATOR'S AND ORGANIZATIONAL MAINTENANCE MANUAL
 TEST FACILITY SET AN/GRM-95(V)2
 (NSN 6625-01-104-8926)**

REPORTING ERRORS AND RECOMMENDING IMPROVEMENTS
 You can help improve this manual. If you find any mistakes or if you know of a way to improve the procedures, please let us know. Mail your letter, DA Form 2028 (Recommended Changes to Publications and Blank Forms), or DA Form 2028-2 located in back of this manual direct to Commander, US Army Communications-Electronics Command and Fort Monmouth, ATTN; DR- SEL-ME-MP, Fort Monmouth, NJ 07703. In either case, a reply will be furnished direct to you.

		Paragraph	Page
CHAPTER	1. INTRODUCTION		
SECTION	I. General		1-1
	II. Description and Data		1-18
CHAPTER	2. INSTALLATION		
SECTION	3. OPERATING INSTRUCTIONS		
SECTION	I. Test Facility, Transmitter TS-2866(V)2/GRM-95(V)2 Controls, Indicators, Fuses, and Connectors		3-1
SECTION	II. Test Facility, Receiver TS-2867(V)2/GSM-951V)2 Controls, Indicators, ... and Connectors		3-9
	III. Accessory Kit, Test Facilities Set MK-1173(V)2/GRM-95(V) Controls, Indicators, Fuses, and Connectors		3-15
	IV. Operation Under Usual Conditions		3-22
	V. Test Facility, Radio Frequency Modules TS-3837(V)2/GRM-95(V)2, Controls, Indicators and Connectors.....		3-22
	VI. Test Fixtures 6A1 through 12A1		3-26
CHAPTER	4. OPERATOR'S MAINTENANCE		
SECTION	I. General.....		4-1
	II. Operator's Preventive Maintenance		4-1
CHAPTER	5. ORGANIZATIONAL MAINTENANCE		
SECTION	I. General.....		5-1
	II. Organizational Preventive Maintenance		5-2
	III. Organizational Replacement of Assemblies		5-13
CHAPTER	6. SHIPMENT, LIMITED STORAGE, AND DEMOLITION TO PREVENT ENEMY USE		
SECTION	I. Shipment and Limited Storage		6-1
	II. Demolition to Prevent Enemy Use		6-1
APPENDIX	A. REFERENCES		A-1

***This manual supersedes TM 11-6625-1696-12, 28 May 1969 including C1, 28 May 1974.**

APPENDIX SECTION	B. COMPONENTS OF END ITEM LIST	
	I. Introduction.....	B-1
	II. Integral Components of End Item.....	B-3
	III. Basic Issue Items.....	B-4
APPENDIX SECTION	C. ADDITIONAL AUTHORIZATION LIST (Not applicable)	
APPENDIX SECTION	D. MAINTENANCE ALLOCATION	
	I. Introduction.....	D-1
	II. Maintenance Allocation Chart	D-3
	III. Tool and Test Equipment Requirements	D-18
	IV. Remarks	D-20
APPENDIX	E. EXPENDABLE SUPPLIES AND MATERIALS LIST (Not applicable)	

LIST OF ILLUSTRATIONS

<i>Figure</i>	<i>Title</i>	<i>Page</i>
1-1	Test Facility, Transmitter TS-2866(V)2/GRM-95(V)2.....	1-2
1-2	Test Facility, Transmitter TS-2866(V)2/GRM-95(V)2, Showing Components Stored in Case, Test Facility, Transmitter CMC 407-702/2	1-3
1-3	Test Facility, Receiver TS-2867(V)2/GRM-95(V)2	1-7
1-4	Test Facility, Receiver TS-2867(V)2/GRM-95(V)2, Showing Stored Components	1-8
1-5	Accessory Kit, Test Facilities Set MK- 1173(V)2/GRM-95(V)2.....	1-10
1-6	Accessory Kit, Test Facilities Set MK-1 173(V)2/GRM-95(V)2, Showing Stored Components	1-12
1-7	Panel, Test, Electrical-Assembly TS-3832/GRM-95(V)2 of Facility, Radio Frequency Modules TS-3837(V)2/G SM-95(V)2.....	1-14
1-8	Accessories Stored in RF Modules Test Facility Case.....	1-15
1-9	Accessories Stored in One-Half of Accessory Kit, Test MK-1985(V)1/GRM-95(V)2.....	1-16
1-10	Accessories Stored in Second-Half of Accessory Kit, Test MK-1985(V)1/GRM-95(V)2.....	1-17
2-1	Typical Packaging of Test Facility Set ANIGRM-95(V)2	2-2
3-1	Transmitter Test Facility, Front Panel	3-3
3-2	Receiver Test Facility, Front Panel	3-10
3-3	Power Supply, Front Panel	3-16
3-4	Test Set, Control-Indicator TS-3031/GRM-95(V)2, Controls, Indicators, and Connectos.....	3-17
3-5	Test Stand, Frequency Multiplier 407-224/1, Controls, Indicators, and Connectors.....	3-19
3-6	Test Set, Interconnecting Box TS-2870/GRM-95(V)2, Controls, Indicators, and Connectors.....	3-21
3-7	Test Facility, Radio Frequency Module, Front Panel	3-23
3-8	Frequency Multiplier Test Fixture TS-3824/GRM-95(V)2	3-27
3-9	Bandpass Filter Test Fixture TS-3825(V)/GRM-95(V)2.....	3-28
3-10	Amplifier Frequency Multiplier Test Fixture TS-38261GRM-95(V)2.....	3-29
3-11	Bandpass Filter Test Fixture TS-3827/GRM-95(V)2	3-31
3-12	Radio Frequency Amplifier Test Fixture TS-38281/GRM-95(V)2.....	3-32
3-13	Frequency Multiplier Test Fixture TS-38291GRM-95(V)2	3-33
3-14	Bandpass Filter Test Fixture TS-3830/GRM-95(V)2	3-34
5-1	Cable Assembly, Special Purpose, Electrical 217-803023-000 (4W1), Wiring Diagram.....	5-8
5-2	Cable Assembly, Special Purpose, Electrical 217-803024-000 (4W2), Wiring Diagram.....	5-8
5-3	Cable Assembly, Special Purpose, Electrical 217-803025-000 (4W3), Wiring Diagram.....	5-8
5-4	Cable Assembly, Special Purpose, Electrical 217-803026-000 (4W4), Wiring Diagram.....	5-8
5-5	Cable Assembly, Special Purpose, Electrical 217-803028-000 (4W5), Wiring Diagram.....	5-9
5-6	Cable Assembly, Special Purpose, Electrical 217-803029-000 (4W6), Wiring Diagram.....	5-9
5-7	Cable Assembly, Special Purpose, Electrical 217-803030-000 (4W7), or 217-803030-001 (1W40), Wiring Diagram.....	5-9
5-8	Cable Assembly, Special Purpose, Electrical 217-803031-000 (4W8), Wiring Diagram.....	5-9
5-9	Cable Assembly, Special Purpose, Electrical 217-457554-001 (5W1), Wiring Diagram.....	5-10
5-10	Cable Assembly, Special Purpose, Electrical 217-457578-001 (5W2), Wiring Diagram.....	5-10
5-11	Transmitter Test Facility Panel, Rear View	5-14
5-12	Transmitter Test Facility Chassis, Rear View.....	5-15
5-13	Receiver Test Facility Panel, Rear View.....	5-17
5-14	Receiver Test Facility Chassis, Rear View	5-18
5-15	Receiver Test Facility Chassis, Front View	5-19
5-16	RF Modules Test Facility Front Panel, Rear View.....	5-21

CHAPTER 1 INTRODUCTION

Section I. GENERAL

1-1. Scope

a. This manual describes Test Facility Set AN/GRM-95(V)2 (fig. 1-1 thru 1-10) and covers its installation and operation, and operator and organizational and operator's maintenance. It includes instructions for operation under usual conditions, cleaning, inspection, troubleshooting, and replacement of assemblies available to the operator and organizational repair technician. No basic items issue list, or items troop installed or authorized list is applicable to this equipment.

b. Operation of Test Facility Set AN/GRM-95(V)2, in conjunction with additional test equipment, to test assemblies of Radio Set AN/GRC-103(V)1 (BAND I), AN/GRC-103(V)2 (BAND II), AN/GRC-103(V)3 (BAND III), and AN/GRC-103(V)4 (BAND IV) is contained in TM 11-5820-540-40-1, -2, and -3.

1-2. Consolidated Index of Army Publications and Blank Forms

Refer to the latest issue of DA Pam 310-1 to determine whether there are new editions, changes or additional publications pertaining to the equipment.

1-3. Maintenance Forms, Records, and Reports

a. *Reports of Maintenance and Unsatisfactory Equipment.* Department of the Army forms and procedures used for equipment maintenance will be those prescribed by TM 38-750. The Army Maintenance Management System.

b. *Report of Packaging and Handling Deficiencies.* Fill out and forward SF 364 (Report of Discrepancy (ROD)) as prescribed in AR 735-11-2/DLAR 4140.55/ NAVMATINST 4355.73/AFR 400-

54/MCO 4430.3E.

c. *Discrepancy in Shipment Report (DISREP) (SF 361).* Fill out and forward Discrepancy in Shipment Report (DISREP) (SF 361) as prescribed in AR 55-38/NAVSUPINST 4610.33B/AFR 75-18/MCO 4610.19C/DLAR 4500.15.

1-4. Administrative Storage

Administrative storage of equipment issued to and used by Army activities will have preventive maintenance performed in accordance with the PMCS charts before storing. When removing the equipment from administrative storage the PMCS should be performed to assure operational readiness. Disassembly and repacking of equipment for shipment or limited storage are covered in paragraphs 6-1 and 6-2.

1-5. Destruction of Army Electronics Materiel

Destruction of Army electronics materiel to prevent enemy use shall be in accordance with TM 750-244-2.

1-6. Reporting Equipment Improvement Recommendations (EIR)

If your AN/GRM-95(V)2 needs improvement, let us know. Send us an EIR. You, the user, are the only one who can tell us what you don't like about your equipment. Let us know why you don't like the design. Put it on an SF 368 (Quality Deficiency Report). Mail it to Commander, US Army Communications-Electronics Command and Fort Monmouth, ATTN:DRSEL-ME-MP. Fort Monmouth, NJ 07703. We'll send you a reply.

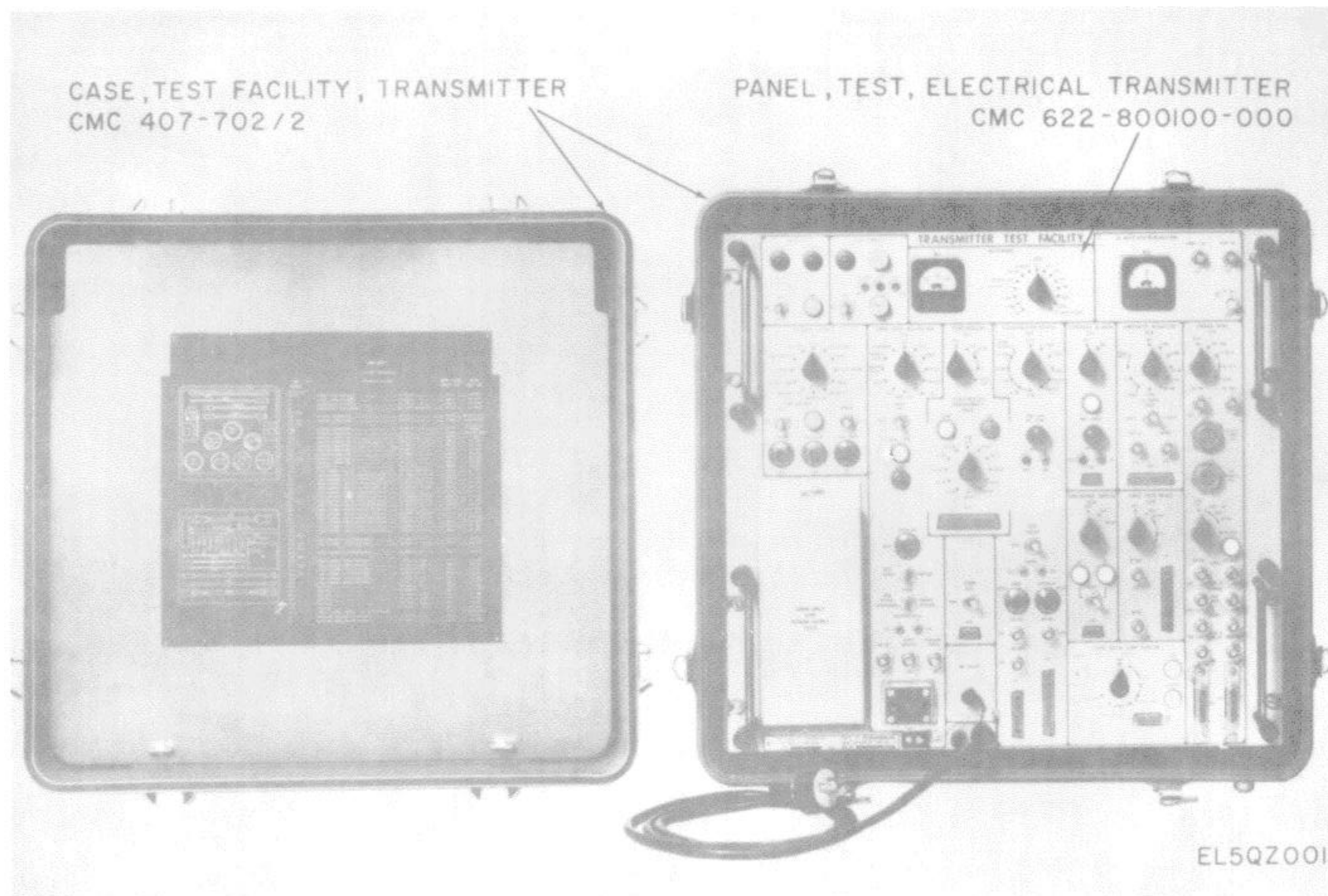
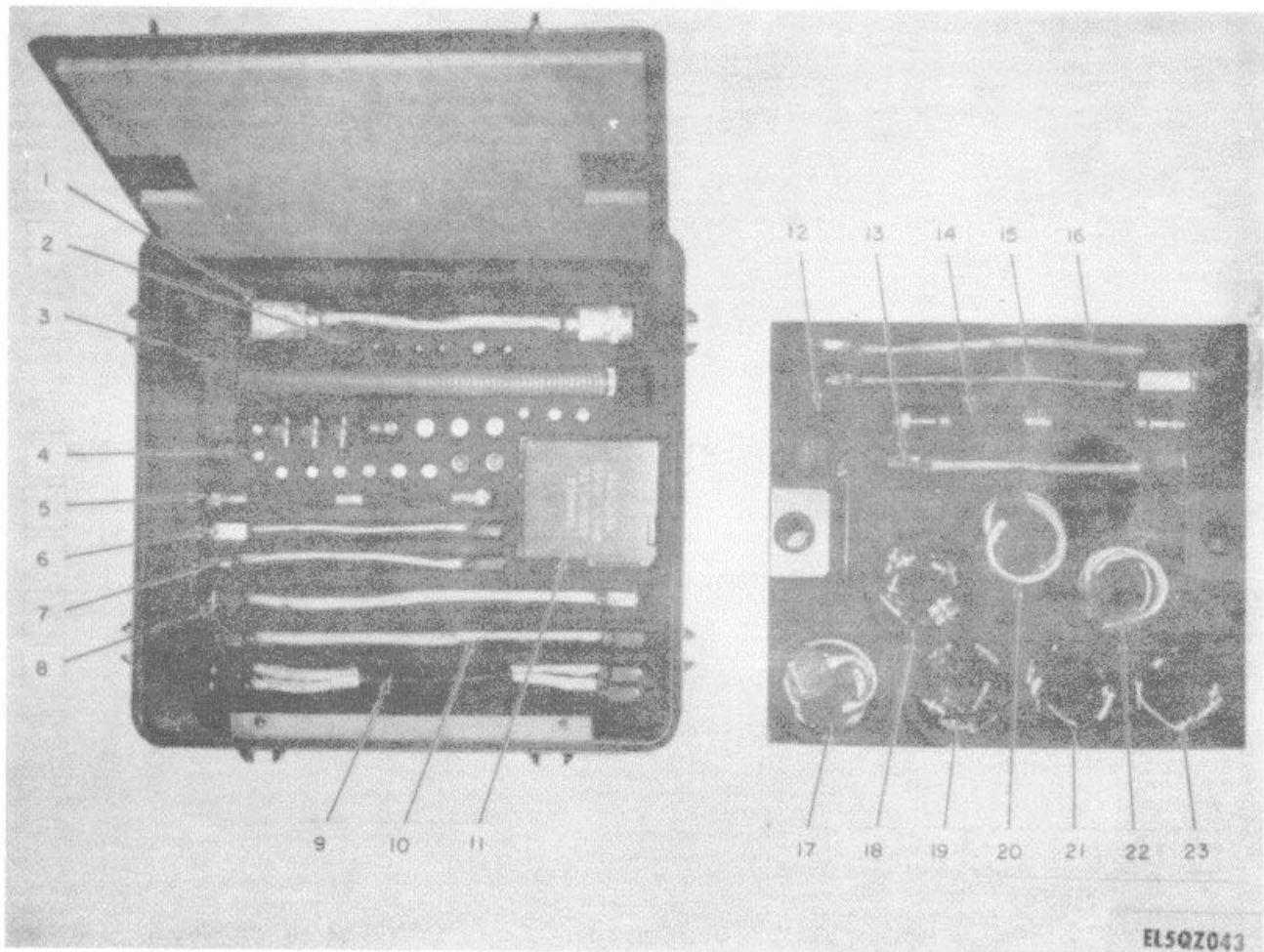

Figure 1-1. Test Facility, Transmitter TS-2866(V)2/GRM-95(V)2.



Legend for fig. 1-2:

- 1 Cable Assembly, Special Purpose, Electrical CX-12028/U (1 ft 3 in.) (1W1)
- 2 Dummy Load, Electrical DA-5301U (5 each) (1A2, 3, 4, 5, 6)
- 3 Network, Impedance Matching CU-1877/U (1Z1)
- 4 Adapter, Connector UG-1879/U (1CP11)
- 5 Hose Assembly, Air Duct MX-8414/GRM-95(V) (1MP2)
- 6 Adapter, Connector UG-274/U (3 each) (1CP1, 2, 3)
- 7 Adapter, Connector UG-914/U (2 each) (1CP4, 5)
- 8 Adapter, Connector UG-201A/U (3 each) (1CP6, 7, 8)
- 9 Adapter, Connector UG-491A/U (1CP9)
- 10 Adapter, Connector UG-1878/U (1CP10)
- 11 Adapter, Connector UG-1880/U (1CP12)
- 12 Adapter, Connector UG-1881U (1CP13)
- 13 Adapter, Connector UG-1882/U (1CP14)
- 14 Adapter, Connector UG-29B/U (2 each) (1CP15, 16)
- 15 Adapter, Connector UG-849A/U (1CP17)
- 16 Adapter, Test MX-8413/U (1CP18)

Figure 1-2. Test Facility, Transmitter TS-2866(V)2/GRM-95(V)2, Showing Components Stored in Case, Test Facility, Transmitter CMC-407- 702/2.

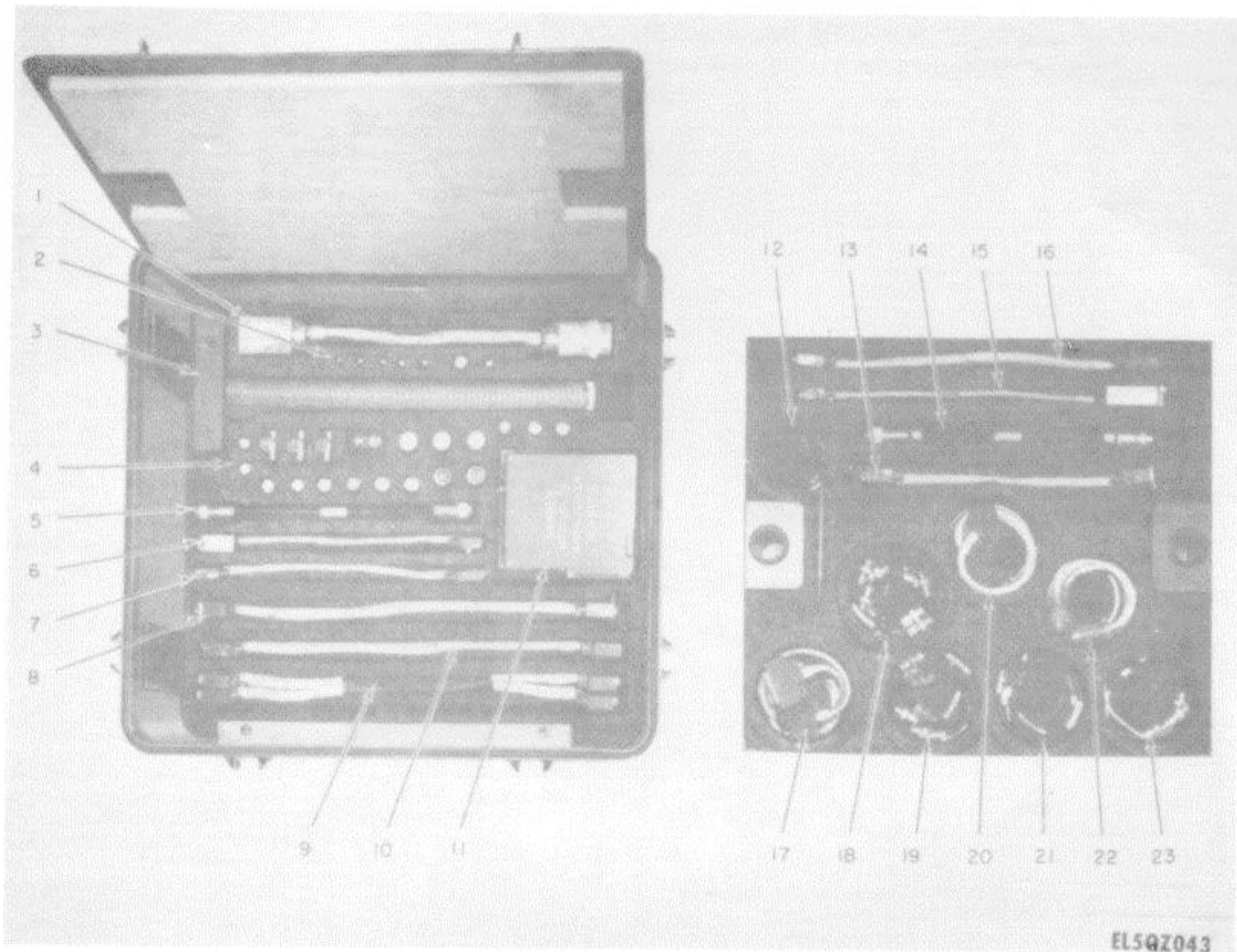

- 1 Dummy Load, Electrical DA-5281U (1A7)
- 2 Dummy Load, Electrical DA-529/U (1A8)
- 3 Network, Impedance Matching CU-1878/U (1Z2)
- 4 Cable Assembly, Radio Frequency CG-3568/U (1 ft) (1W29)
- 5 Cable Assembly Special Purpose, Electrical CX-12040/U (1 ft) (1W14)
- 6 Cable Assembly Special Purpose, Electrical CX-12032/U (1 ft) (1W5)
- 7 Cable Assembly Special Purpose, Electrical CX-120381U (1 ft 6 in.) (1W12)
- 8 Cable Assembly Special Purpose, Electrical CMC 217-803030-001 (1 ft) (1W40)
- 9 Cable Assembly Special Purpose, Electrical CX-12037/U (1 ft 6 in.) (1W11)
- 10 Cable Assembly Special Purpose, Electrical CX-12029/U (1 ft 6 in.) (1W2)
- 11 Power Supply, Subassembly MX-8415/GRM-95(V) (1A9)
- 12 Lead, Test CX-120421U (2 ft) (1W34)
- 13 Lead, Test CX-120431U (2 ft) (1W35)
- 14
- 15
- 16
- 17
- 18
- 19
- 20
- 21
- 22
- 23

Figure 1-2. Test Facility, Transmitter TS-2866(V)2/GRM-95(V)2, Showing Components Stored in Case, Test Facility, Transmitter CMC-407-702/2- Continued

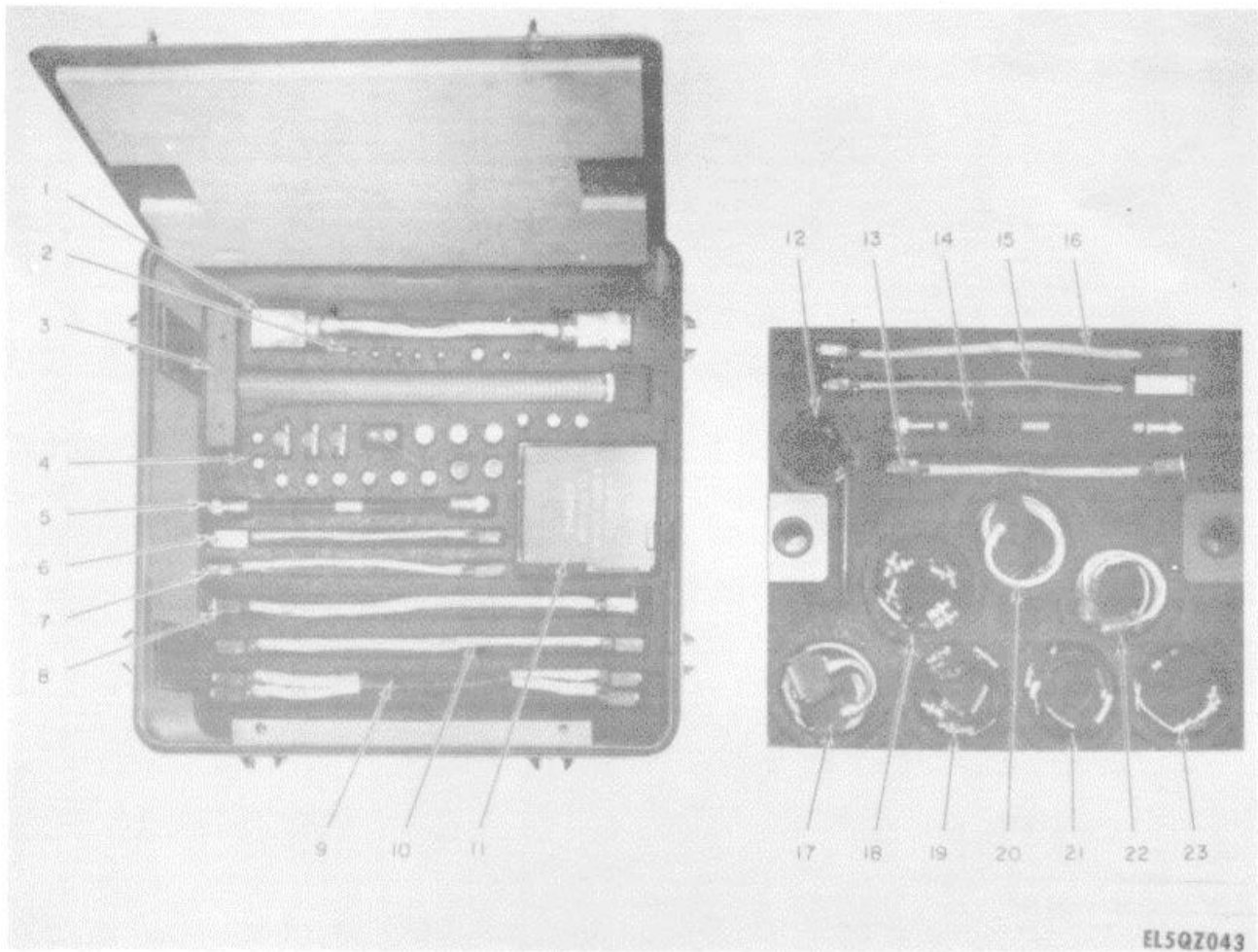

Legend for fig. 1-2:

- 20 Cable Assembly, Radio Frequency CG-409H/U (1 ft) (3 each) (1W21, 22, 23)
- 20 Cable Assembly Special Purpose, Electrical CX-12031/U (1 ft 3 in.) (1W4)
- 20 Cable Assembly Special Purpose, Electrical CX-12041/U (1 ft 6 in.) (1W15)
- 21 Cable Assembly, Radio Frequency CG-3571/U (1 ft) (1W33)
- 21 Lead, Test CX-12044/U (2 ft) (1W36)
- 21 Lead, Test CX-12045/U (2 ft) (1W37)
- 21 Lead Set, Test CX-12046/U (8 in.) (1W38)
- 22 Cable Assembly Special Purpose, Electrical CX-12034/U (1 ft 6 in.) (2 each) (1W7, 8)
- 23 Cable Assembly, Radio Frequency CG-3567/U (6 in.) (2 each) (1W27, 28)
- 23 Cable Assembly, Radio Frequency CG-3570/U (6 in.) (1W32)
- 23 Lead, Test CX-12047/U (2 ft) (1W39)

Figure 1-2. Test Facility, Transmitter TS-2866(V)2/GRM-95(V)2, Showing Components Stored in Case, Test Facility, Transmitter CMC-407- 702/2-Continued,

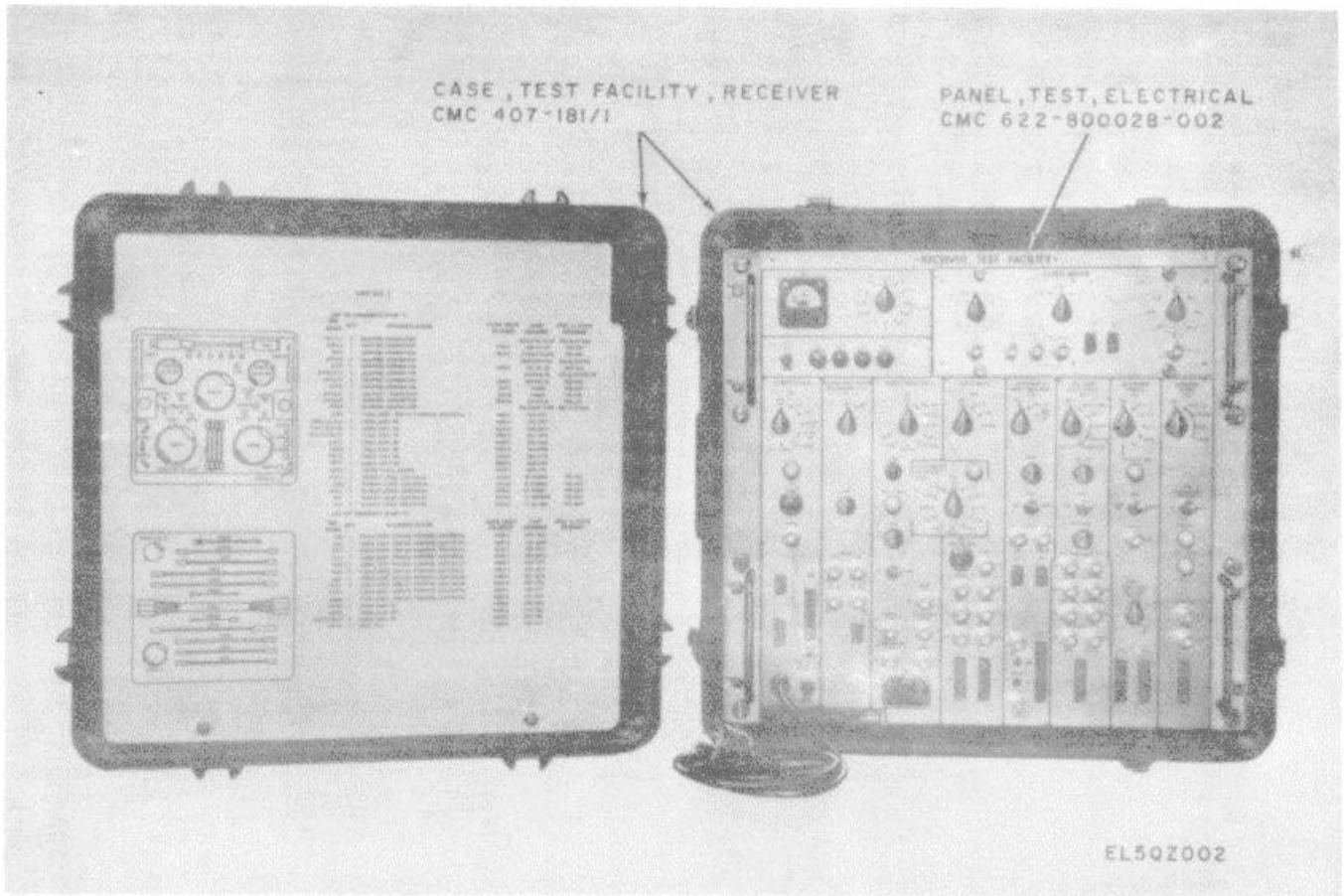

Figure 1-3. Test Facility, Receiver TS-2867(V)2/GRM-95(V)2.

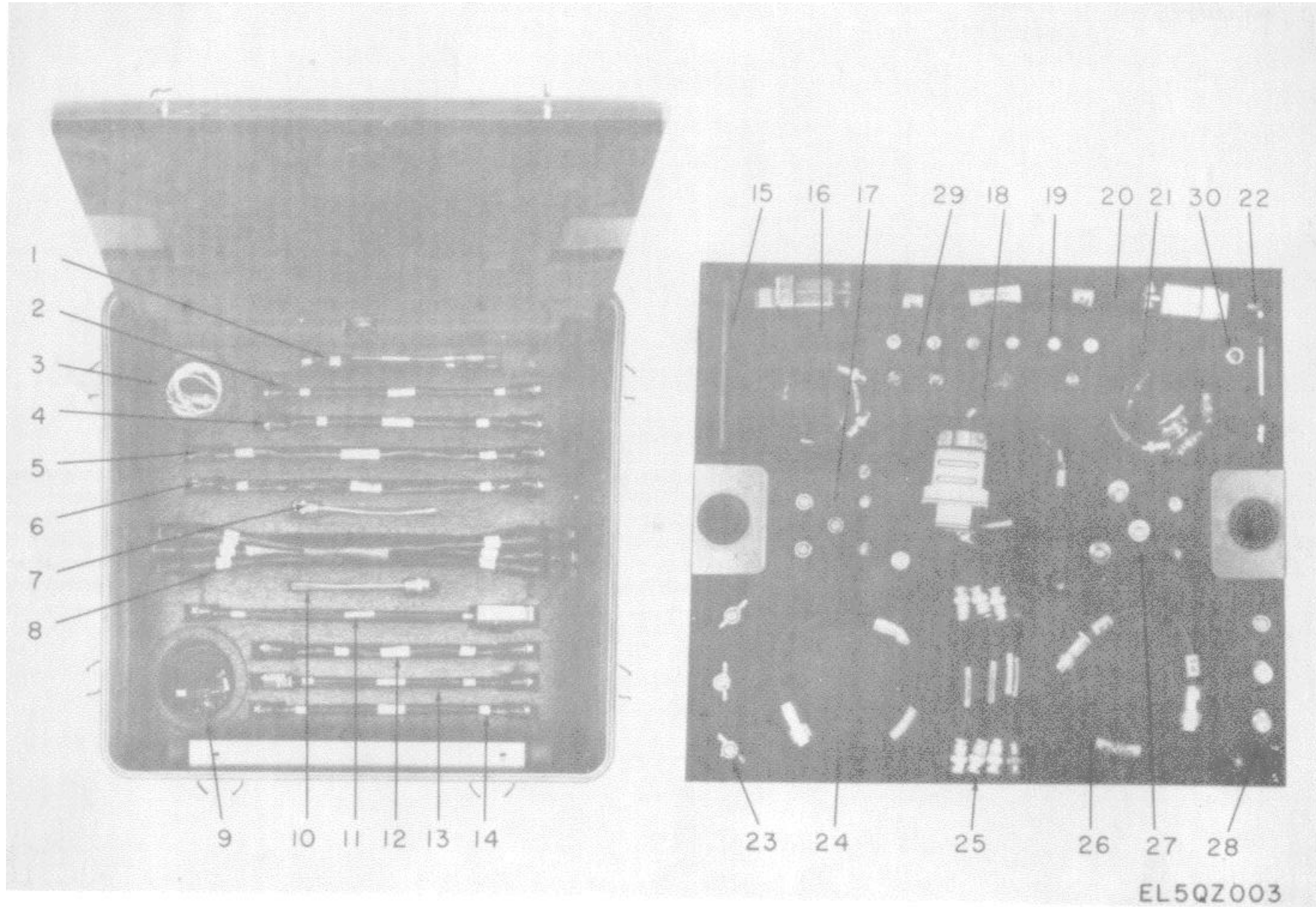

Figure 1-4. Test Facility, Receiver TS-2867(V)2/GRM-95(V)2, Showing Stored Components.

Legend for fig. 1-4

- 1 Lead, Test CX-12046/U (8 in.) (2W34)
- 2 Cable Assembly Special Purpose, Electrical CX-120259/U (1 ft) (2W10)
- 3 Cable Assembly, Radio Frequency CG-8567/U (2 ft) (3 each) (2W29, 30, 31)
- 4 Cable Assembly Special Purpose, Electrical CX-12058/U (1 ft) (2W7)
- 5 Cable Assembly Special Purpose, Electrical CX-12057/U (1 ft) (2W6)
- 6 Cable Assembly Special Purpose, Electrical CX-12056/U (1 ft 3 in.) (2W5)
- 7 Cable Assembly, Radio Frequency CG-8567/U (6 in.) (2W25)
- 8 Cable Assembly Special Purpose, Electrical CX-12062/U (1 ft 3 in.) (2W12)
- 9 Cable Assembly Special Purpose, Electrical CX-12059/U (1 ft 8 in.) (2 each) (2W8, 9)
- 10 Cable Assembly, Radio Frequency CG-8570/U (6 in.) (2W26)
- 11 Cable Assembly Special Purpose, Electrical CX-12055/U (1 ft 3 in.) (2W4)
- 12 Cable Assembly Special Purpose, Electrical CX-12054/U (1 ft) (2W3)
- 13 Cable Assembly Special Purpose, Electrical CX-12053/U (1 ft) (2W2)
- 14 Cable Assembly Special Purpose, Electrical CX-12052/U (1 ft) (2W1)
- 15 Cover, Plate, Access CW-1083/GRM-95(V) (2MP2)
- 16 Cable Assembly, Radio Frequency CG-109HIU (3 ft) (4 each) (2W13, 14, 15, 16)
- 17 Adapter, Connector UG-849AIU (2 each) (2CP4, 5)
 Adapter, Connector UG-1890/U (2CP6)
 Adapter, Connector UG-914/U (2 each) (2CP7, 8)
 Adapter, Connector UG-29B/U (2CP9)
 Adapter, Connector CMC 504-800055-000 (2CP24), (OS, 21170 BNC female/SMA female)
- 18 Cable Assembly, Radio Frequency CG-8571/U (3 ft) (2W33)
 Cable Assembly Special Purpose, Electrical CMC 217-800179-000 (2 ft) (2W35)
- 19 Dummy Load, Electrical DA-531/U (2 each) (2A2, 3)
 Dummy Load, Electrical DA-532/U (2A4)
 Dummy Load, Electrical DA-533/U (2 each) (2A5, 6)
 Dummy Load, Electrical DA-534/U (2A7)
 Dummy Load, Electrical CMC 192-462 (2A8)
- 20 Cable Assembly, Special Purpose, Electrical CX-12061/U (1 ft 3 in.) (2WII)
- 21 Cable Assembly, Radio Frequency CG-409H/U (1 ft 6 in.) (4 each) (2W17, 18, 19, 20)
- 22 Cable Assembly, Radio Frequency CG-3573/U (4.8 in.) (2W32)
- 23 Adapter, Connector UG-274C/U (3 each) (2CP1, 2, 3)
- 24 Cable Assembly, Radio Frequency CG-8568/U (2 ft) (2W27)
- 25 Cable Assembly, Radio Frequency CG-409H/U (6 in.) (4 each) (2W21, 22, 23, 24)
- 26 Cable Assembly, Radio Frequency CG-8569/U (2 ft) (2W28)
- 27 Adapter, Connector UG-201A (3 each) (2CP10, 11, 12)
 Adapter, Connector UG-1878/U (2 each) (2CP13, 14)
 Adapter, Connector CMC 504-800056-000 (2CP25), (OS 21020 N male/SMA female)
- 28 Adapter, Connector UG-1891/U (2CP15)
 Adapter, Connector UG-1879/U (2 each) (2CP16, 17)
 Adapter, Connector UG-665A/U (2 each) (2CP18, 19)
 Adapter, Connector UG-491B/U (2CP20)
- 29 Adapter, Connector CMC 504-800053-000 (2 each) (2CP21, 2CP22) (OS 21190 BNC female/SMA male)
- 30 Adapter, Connector CMC 504-800054-000 (2CP23) (OS 21010 N female/SMA female)

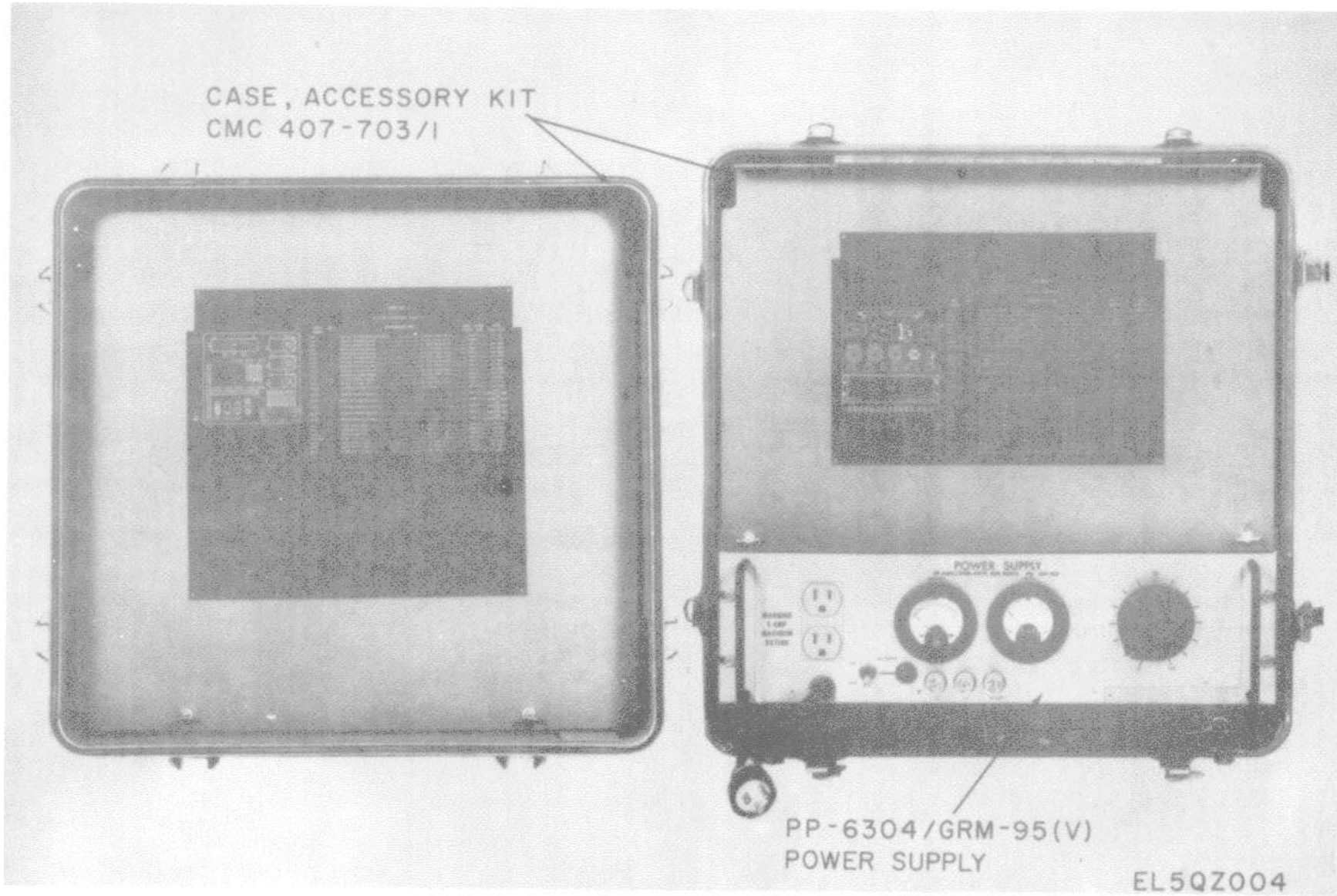

Figure 1-5. Accessory Kit, Test Facilities Set MK-1173(V)2/GRM-95(V)2.

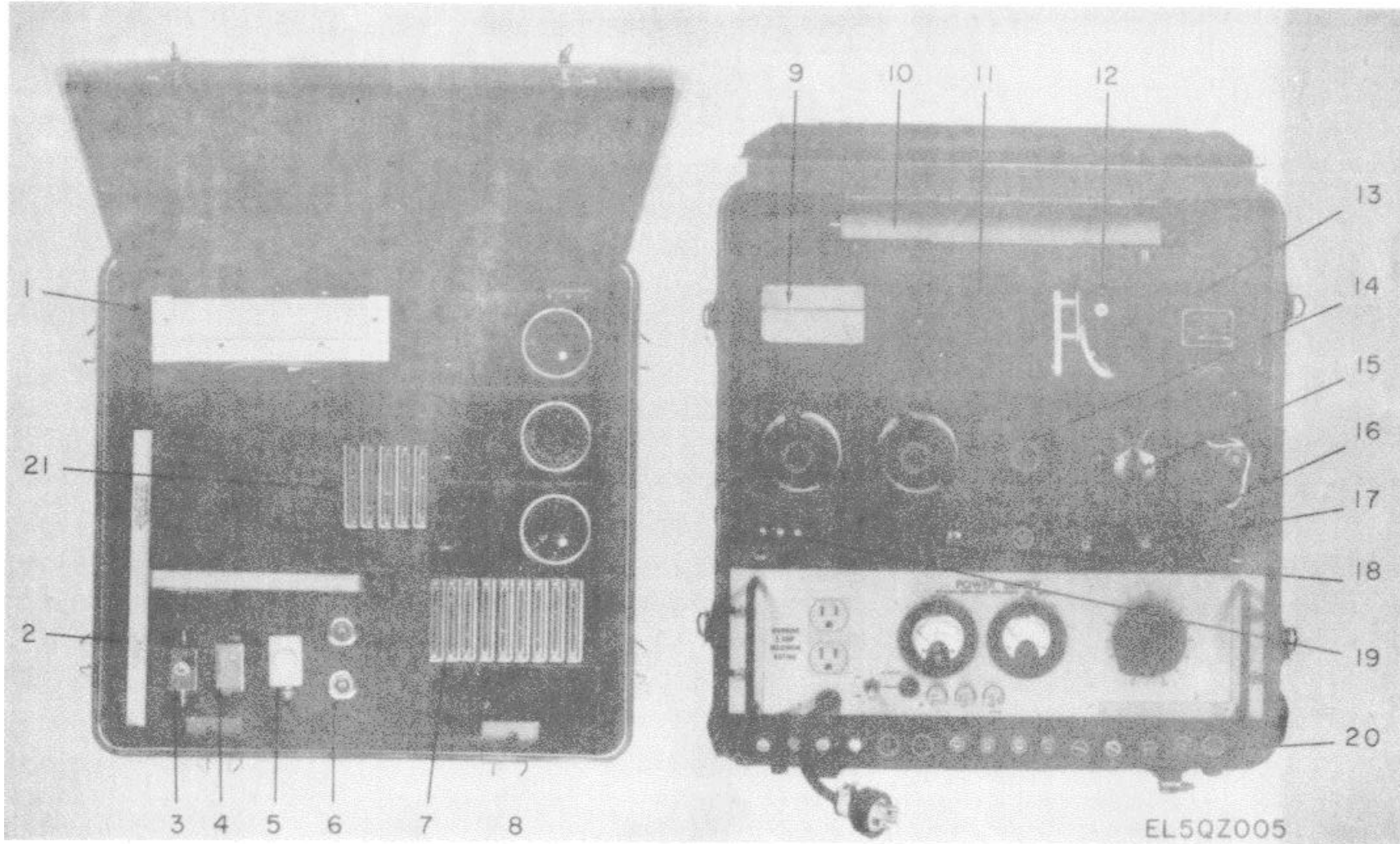

Figure 1-6. Accessory Kit, Test Facilities Set MK-1173(V)2/GRM-95(V)2, Showing Stored Components.

Legend for fig. 1-6:

- 1 Test Set, Interconnecting Box TS-2870/GRM-95(V) (3A3)
- 2 Gage, Depth, Fixed TL-766/GRM-95(V) (3MP2)
Gage, Depth, Fixed TL-767/GRM-95(V) (3MP3)
Gage, Depth, Fixed TL-768/GRM-95(V) (3MP4)
- 3 Coupler, Directional CU-1880/U (3A22)
- 4 Dummy Load, Electrical DA-539/U (3A30)
- 5 Bridge, Return Loss RF-238/GRM-95(V) (3A23)
- 6 Filter, Low Pass F-1270/U (2 each) (3FL4, 5)
- 7 Printed Wiring Board PL-1251/GRM-95(V) (3A5)
Printed Wiring Board PL-1252/GRM-95(V) (3A6)
Printed Wiring Board PL-1253/GRM-95(V) (3A7)
Printed Wiring Board PL-1254/GRM-95(V) (3A8)
Printed Wiring Board PL-1255/GRM-95(V) (3A9)
Printed Wiring Board PL-1256/GRM-95(V) (3A10)
Printed Wiring Board PL-1257/GRM-95(V) (3A11)
Printed Wiring Board PL-1258/GRM-95(V) (3A12)
Printed Wiring Board PL-1259/GRM-95(V) (3A13)
- 8 Filter, Bandpass F-1267/U (3FL1)
Filter, Bandpass F-1268/U (3FL2)
Filter, Bandpass F-1269/U (3FL3)
- 9 Bridge, Impedance-Dummy Load MK-1174/U (3A14)
- 10 Coupler, Directional CU-1879/U (3A21)
- 11 Test Set, Control Indicator TS-3031/GRM-95(V)2 (3A1)
- 12 Test Stand, Frequency Multiplier CMC-407-224/1 (3A2)
- 13 Dummy Load, Electrical DA-437/GRC-103(V) (3A24)
- 14 Attenuator, Variable CN-1292/U (3AT6)
Attenuator, Variable CN-1293/U (3AT7)
Attenuator, Variable CN-1294/U (3AT8)
- 15 Switch, Radio Frequency Transmission Line SA-16571U (3S1)
- 16 Converter, Frequency Electronic CV-2500/GR (3A4)
- 17 Attenuator, Fixed CN-1286/U (3AT4)
Attenuator, Fixed CN-1287/U (3AT5)
Detector, Radio Frequency RF-237/U (2 each) (3A19, 20)
- 18 Parts Kits, Electronic Equipment CMC 457-969 (3A31)
- 19 Mixer, Crystal, Coaxial CV-2343/U (3A29)
- 20 Dummy Load, Electrical DA-531/U (3A25)
Dummy Load, Electrical DA-532/U (3A26)
Dummy Load, Electrical DA-533/U (3A27)
Dummy Load, Electrical DA-534/U (3A28)
Attenuator, Fixed CN-1285/U (2 each) (3AT2, 3)
Attenuator, Fixed CN-1288/U (3AT9)
Attenuator, Fixed CN-1289/U (3AT10)
Attenuator, Fixed CN-1290fU (3AT11)
Attenuator, Fixed CN-1291/U (3AT12)
Dummy Load, Electrical DA-535/U (3A15)
Dummy Load, Electrical DA-536/U (3A16)
Dummy Load, Electrical DA-537fU (3A17)
Dummy Load, Electrical DA 538/U (3A18)
Attenuator, Fixed CN-1284/U (3AT1)
- 21 Printed Wiring Board CMC 220-800476-000 (3A32)
Printed Wiring Board CMC 220-800477-000(3A33)
Printed Wiring Board CMC 220-800478-000 (3A34)
Printed Wiring Board CMC 220-800479-000 (3A35)
Printed Wiring Board CMC 220-800480-000 (3A36)

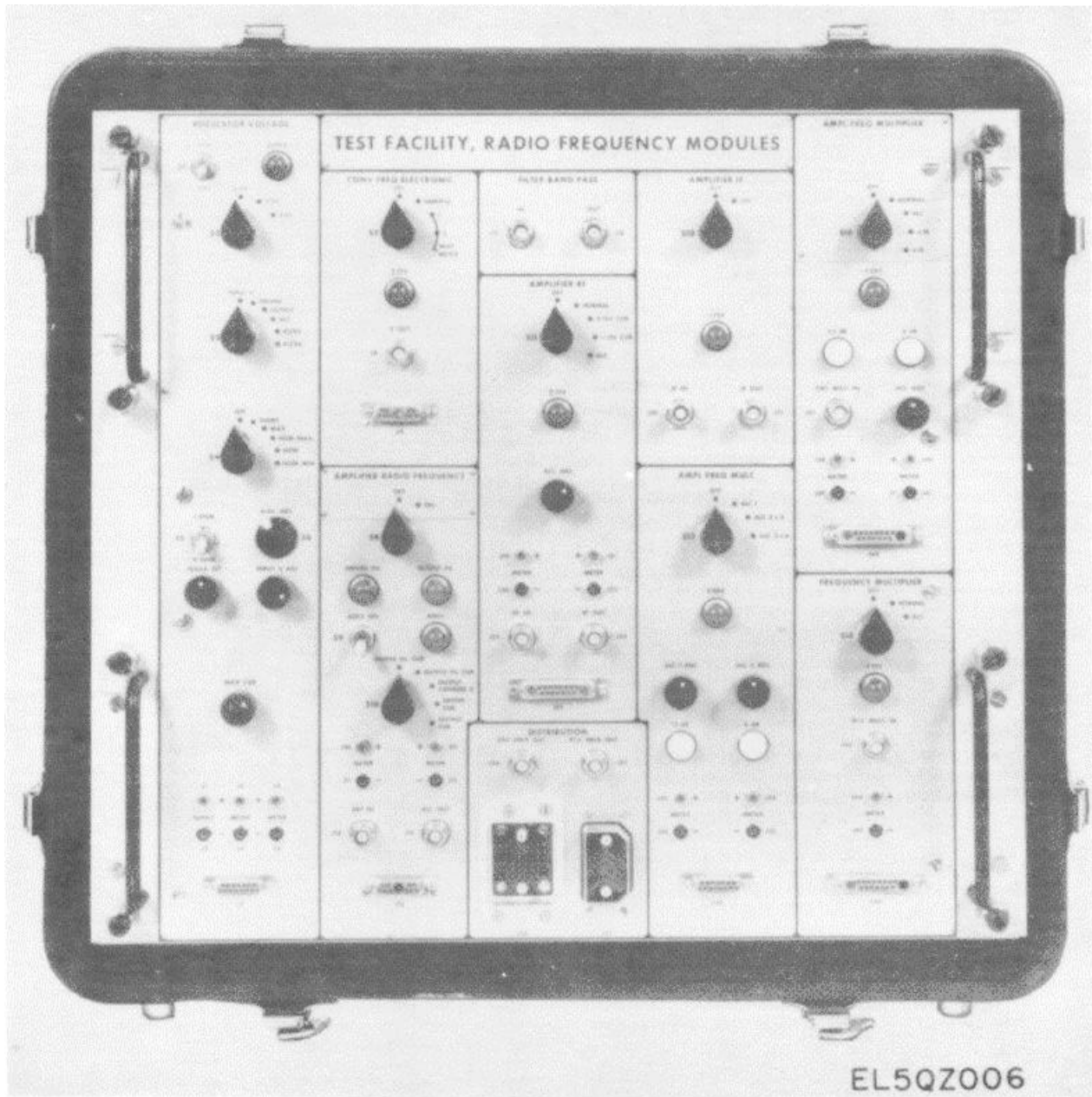
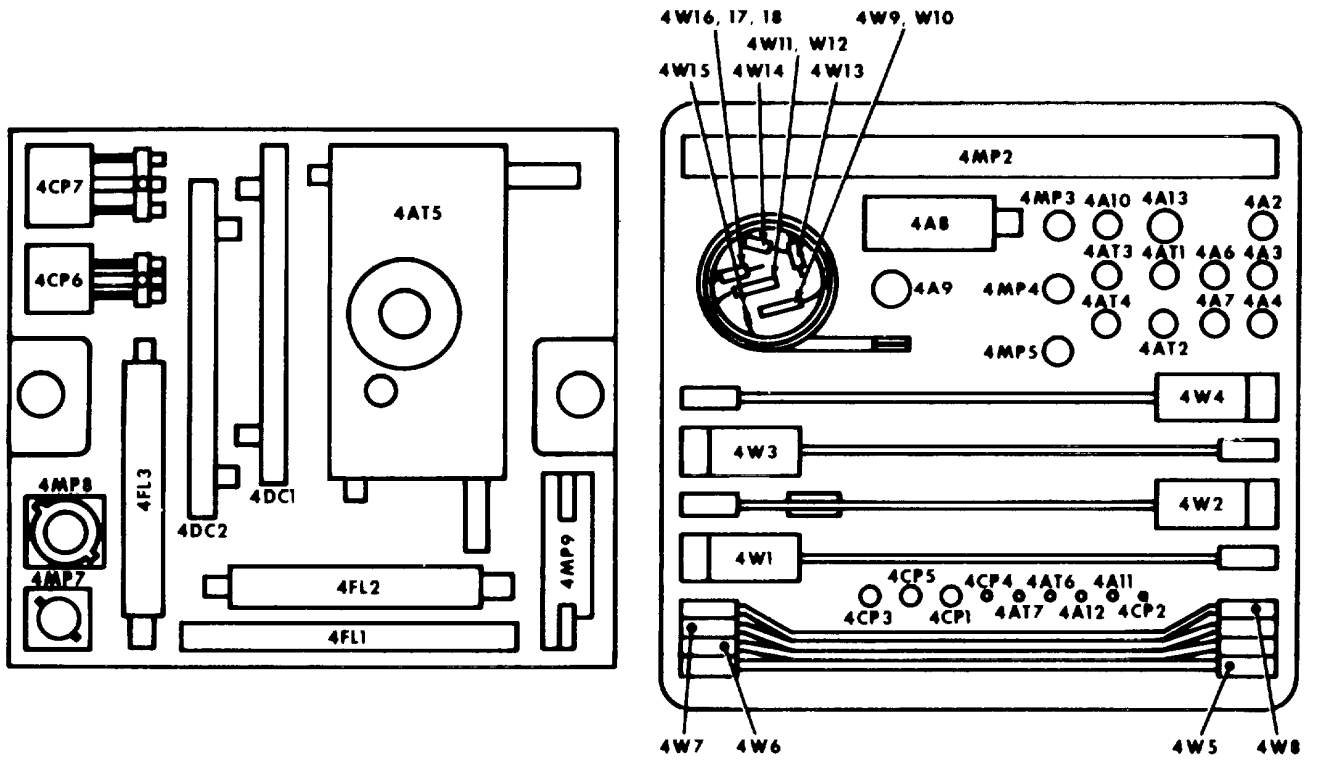

Figure 1-7. Panel, Test, Electrical-Assembly TS-3832/GRM-95(V)2 of Facility, Radio Frequency Modules TS-3837/GRM-95(V)2



EL5QZ007

Figure 1-8. Accessories Stored in RF Modules Test Facility Case.

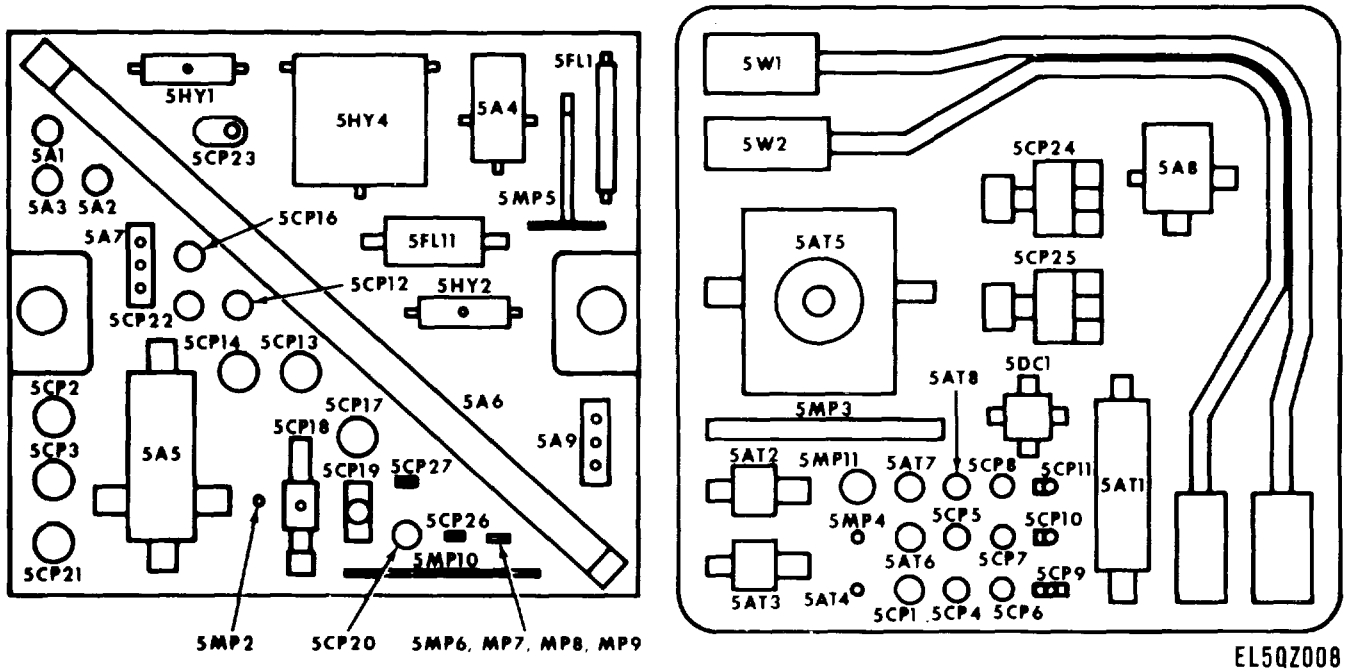
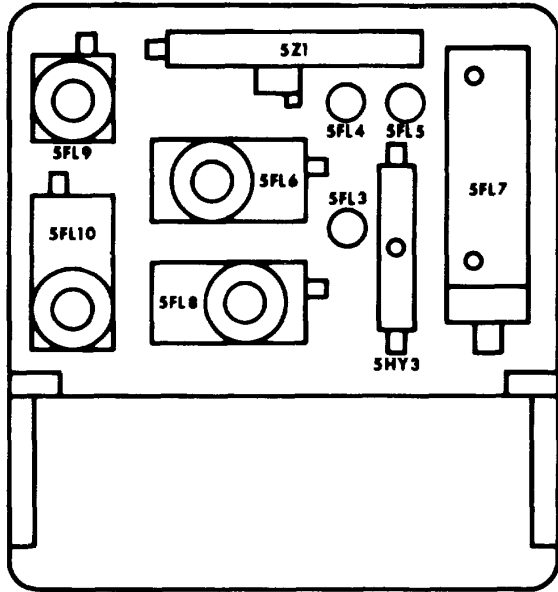

Figure 1-9. Accessories Stored in One Half of Accessory Kit, Test MK-1985(V)1/GRM-95(V)2.

**1-8. Accessory Kit, Test MK-1985(V)1/GRM-95(V)2
(fig. 1-9 and 1-10)**

The items in the lists below are the accessories stored in the Accessory Kit, Test MK-1985(V)1/GRM-95(V)2. The location of each item is identified by its reference designation as shown in figures 1-9 and 1-10.

a. Accessories Shown in Figure 1-9:



EL5QZ009

Figure 1-10. Accessories Stored in Second Half of Accessory Kit, Test MK-1985(V)1/GRM-95(V)2.

Reference Designation	Nomenclature	Description
5A1, 5A2, 5A3	Detector, Radio Frequency 280-800155-000	
5A4	Divider, Power 280-800156-000	
5A5	Bridge, Vswr 280-800157-000	
5A6	Trombone, Adjustable Air Line 280-800158-000	
5A7	Mixer, Double Balanced 280-800159-000	
5A8	Detector, Vswr 280-800160-000	
5A9	Mixer, Double Balanced 280-800161-000	
5AT1	Attenuator, Fixed- 20dB, 50W 203-800008-000	
5AT2	Attenuator, Fixed- 10 dB, 20W 203-800009-000	
5AT3	Attenuator, Fixed-6 dB, 20W 203-800010-000	
5AT4	Attenuator, Fixed-6 dB 203-800011-000	
5AT5	Attenuator, Variable-0 to 10 dB Continuous 203-800012-000	230-416 Narda N Male
5AT6	Termination, Short Circuit 336-800058-000	230-412 Narda N Female
5AT7	Termination, Short Circuit 336-800059-000	MICRO-LABS TS-5MC
5AT8	Termination, Short Circuit 336-800060-000	00-21020 N Plug/SMA Jack
5CP1	Adapter, Connector SM-A-408546	GR 874 QNJL
5CP2, 5CP3	Adapter, Connector 504-800067-000	
5CP4, 5CP5	Adapter, Connector UG-57B/U	OS-21030, N Jack/SMA Jack
5CP6, 5CP7, 5CP8	Adapter, Connector SM-A-40778	OS-20200-2 two-way power di- vider (input-SMA Plug, output-two g SMA Jack s)
5CP9	Adapter, Connector 504-800070-000	OS-219 Right angle SMA Plug/Jack
5CP10, 5CP11	Adapter, Connector M55339/02-40001	
5CP12	Adapter, Connector SM-A-408135	GR 874-QBJL
5CP13, 5CP14	Adapter, Connector SM-A-408163	

Reference

Designation	Nomenclature	Description
5CP16	Adapter, Connector UG-636A/U	GR 874-QMMPL
5CP17	Adapter, Connector 504-800074-000	
5CP18	Adapter, Connector 504-800075-000	
5CP19	Adapter, Connector UG-107B/U	
5CP20	Adapter, Connector UG-643/U	GR 874-QNPL
5CP21	Adapter, Connector 504-800078-000	
5CP22	Adapter, Connector UG-564A/U	
5CP23	Adapter, Connector UG- 1882/U	
5CP24	Probe, Waveguide-Transmitter 280-800148-001	
5CP25	Probe, Waveguide-Receiver 280-800148-002	
5CP26, 5CP27	Probe, Waveguide 280-800150-000	
5DC1	Coupler, Directional 280-800162-000	
5FL1	Filter, Low Pass 246-800043-000	
5FL11	Filter, Low Pass 246-800088-000	
5HY1, 5HY2	Circulator, 3 Port 280-800111-000	
5MP4	Circulator, 3 Port 280-800164-000	
5MP2	Post, Electrical-Mechanical Equipment 718-800080-000	
5MP3	Shorting Tool 920-803036-000	
5MP4	Gage, Alignment 920-803037-000	
5MP5	Screwdriver, Right Angle 920-803038-000	
5MP6	MP7MP85MP9Plate, Electrical Shield 656-800075-000	
5MP6, 5MP7 5MP8, 5MP9	Plate, Electrical Shield 656-800076-000	
5MP10	Plate, Electrical Shield 656-800076-000	
5MP11	Knob 610-800006-000	
5W1	Cable Assembly, Special Purpose, Electrical CX-12028/U (3 ft)	
5W2	Cable Assembly, Special Purpose, Electrical CX-12061/U (3 ft)	

b. Accessories Shown in Figure 1-10:

Reference Designation	Nomenclature
5FL3	Filter, Low Pass 246-800091-000
5FL4, 5FL5	Filter, Low Pass 246-800092-000
5FL6	Filter, Bandpass 246-800093-000
5FL7	Filter, Bandpass 246-800094-000
5FL8	Filter, Bandpass 246-800095-000
5FL9	Filter, Bandpass 246-800096-000
5FL10	Filter, Bandpass 246-800097-000
5HY3	Circulator 280-800163-000
5Z1	Shifter, Phase 280-800165-000

Section II. DESCRIPTION AND DATA

1-9. Purpose and Use

a. Test Facility Set AN/GRM-95(V)2, when used with additional test equipment, permits the operator to troubleshoot, aline, and check the characteristics and parameters of the assemblies of Radio Set AN/GRC-103(V)1,2, 3 and 4 shown below:

Assembly	Used in-
Case, Reciever CY-4698/ GRC-103(V) 1A2.	Receiver, Radio R-1329(P)/GRC- 103(V).
Radio receiver 1RE 1	Receiver, Radio R-1329(P)/GRC-103(V).
Electrical frequency synthesizer 1RE1A2.	Radio receiver 1RE1
Pulse from restorer	Radio receiver 1RE 1.

Assembly	Used in-
1RE1A3.	
Electrical frequency limiter-discriminator 1RE1A4.	Radio receiver IRE1.
Amplifier-frequency multiplier 1RE1A5.	Radio receiver 1RE 1.
Video amplifier 1RE1AR1	Radio receiver IRE1.
Intermediate-frequency amplifier 1 RE1AR2.	Radio receiver IRE1.
Bandpass filter 1RE FL1	Radio receiver IRE 1.
Power supply 1RE1PS1.	Radio receiver 1RE1
Amplifier-Converter AM-4316/GRC-103(V).	Radio receiver R-1329(P)GRC103(V).
Electronic frequency converter 2A A2.	Amplifier-Converter AM-43 16GRC-103(V).

<i>Assembly</i>	<i>Used in-</i>	<i>Assembly</i>	<i>Used in-</i>
Frequency multiplier 2A1A2A1.	Electronic frequency converter 2A1A2.	Duplexer Subassembly 33A1A1	Amplifier Converter AM-4317 GRC-103(V).
Frequency mixer stage 2A1A2A2.	Electronic frequency converter 2A1A2.	IF. Amplifier 33AR1	Amplifier Converter AM-4317/GRC-103(V).
Intermediate-frequency amplifier 2A1A2AR1.	Electronic frequency converter 2A1A2.	Amplifier-Filter 33AR1A1	Amplifier Converter AM-4317/GRC-103(V).
Radio frequency amplifier 2A1AR1.	Radio frequency tuner 2A1.	Frequency Mixer Stage 33A7	Amplifier Converter AM-4317/GRC-103(V).
Control-indicator 2A2	Amplifier-Converter AM-4316/G RC-103(V).	Signal Level Control-Monitor 33A5	Amplifier Converter AM-4317/G RC-103(V).
Electronic switch 2A4	Amplifier-Converter AM-4316/G RC-103(V).	Low Pass Filter 33FL1	Amplifier Converter AM-4317/GRC-103(V).
Power supply 2PS1	Amplifier-Converter AM-43161GRC-103(V).	RF Power Monitor 33A3	Amplifier Converter AM-4317/GRC-103(V).
Case, Transmitter CY-4637/GRC- 103(V).	Transmitter, Radio T-983(P)/G RC-103(V).	Control Indicator 33A4	Amplifier Converter AM-4317/GRC-103(V).
Centrifugal fan 5A2D1	Transmitter, Radio T-983(P)/GRC-103(V).	Amplifier-Converter	Radio Set ANIGRC-103(V)2
Radio transmitter 5TR1	Transmitter, Radio T-983(P)/GRC- 103(V).	Frequency Multiplier Group 34A2	Amplifier Converter AM-4318/GRC-103(V).
Electrical frequency synthesizer 5TR1A2.	Radio transmitter 5TR1	IF. Amplifier 34AR1	Amplifier Converter AM-4318/GRC-103(V).
Alarm control 5TR1A3	Radio transmitter 5TR1	Amplifier-Filter 34AR1A1	Amplifier Converter AM-4318/GRC-103(V).
Amplifier-frequency multiplier 5TR1A4.	Radio transmitter 5TR1	Frequency Multiplier 34A2A1	Amplifier Converter AM-4318/GRC-103(V).
Amplifier-monitor 5TR1A5.	Radio transmitter 5TR1	Frequency Multiplier 34A2A2	Amplifier Converter AM-4318/GRC-103(V).
Power supply 5TR1PS1	Radio transmitter 5TR1	Frequency Mixer Stage 34A7	Amplifier Converter AM-4318/GRC-103(V).
Amplifier-Frequency Multiplier AM-4320/GRC-103(V).	Transmitter, Radio T-983(P)/GRC-103(V).	Signal Level Control-Monitor 34A5	Amplifier Converter AM-4318/GRC-103(V).
Electronic switch 6A 1	Amplifier-Frequency Multiplier AM-4320/ GRC-103(V).	Duplexer Subassembly 34A1A1	Amplifier Converter AM-4318/GRC-103(V).
Frequency multiplier assembly 6A2.	Amplifier-Frequency Multiplier AM-43201 GRC-103(V).	Bandpass Filter 34A2FL1	Amplifier Converter AM-4318/GRC- 103(V).
Control-indicator 6A3	Amplifier-Frequency Multiplier AM-4320/ GRC- 103(V).	Low Pass Filter 34A2A2FL1	Amplifier Converter AM-4318/GRC-103(V).
Rf power level control 6A5.	Amplifier-Frequency Multiplier AM-4320/ GRC-103(V).	Low Pass Filter 34A2A2FL2	Amplifier Converter AM-4318/GRC-103(V).
Receiver-Transmitter Order Wire, RT-773/ GRC-103(V).	Radio Set AN/GRC-103(V)	RF Power Monitor 34A3	Amplifier Converter AM-4318/GRC-103(V).
Telephone signal converter 9A3.	Receiver-Transmitter Order Wire RT773/GRC-103(V).	Low Pass Filter 34FL1	Amplifier Converter AM-4318/GRC-103(V).
Amplifier assembly 9A4	Receiver-Transmitter Order Wire RT-773/ GRC-103(V).	Control Indicator 34A4	Amplifier Converter AM-4318/GRC-103(V).
Frequency Multiplier Group 33A2	Amplifier Converter AM-43171 (GRC-103(V).	Amplifier-Converter	Radio Set AN/GRC-103(V)3.
Frequency multiplier 33A2A1	Amplifier Converter AM-4317/GRC-103(V).	Amplifier-Frequency Multiplier 103(V) and Amplifier-Frequency Multiplier AM-4321A()IGRC-103V)37	Radio Set AN/GRC-103(V)2. AM-4321()/GRC-
Frequency Multiplier 33A2A2	Amplifier Converter AM-4317/GRC-103(V).	Frequency Multiplier 37A1	Amplifier-Frequency Multiplier AM-4321/ GRC-103(V).
Bandpass Filter 33A2FL1	Amplifier Converter AM-4317/GRC-103(V).	Voltage Regulator Assembly 37AR1A1A1	Amplifier-Frequency Multiplier AM-43211 GRC-103(V).
Low Pass Filter 33A2A2FL1	Amplifier Converter AM-4317/GRC-103(V).		
Low Pass Filter 33A2A2FL2	Amplifier Converter AM-4317/GRC-103(V).		

Assembly	Used in-	Assembly	Used in-
RF Power Monitor 37AR1A2	Amplifier-Frequency Multiplier AM-4321/GRC- 103(V).	Amplifier-Frequency Multiplier 40A2	Radio Set AN/GRC-103(V)4. pplier AM-4323/GRC- 103(V)40
Low Pass Filter 37ARIAiFL1	Amplifier-Frequency Multiplier AM-43211 GRC-103(V).	Voltage Regulator 40A3	Amplifier-Frequency Multiplier AM-43231 GRC-103(V).
Control-Indicator 37A2	Amplifier-Frequency Multiplier AM-4321/GRC-103(V).	Radio Frequency Amplifier 40AR1	Amplifier-Frequency Multiplier AM-43231 GRC-103(V).
Radio Frequency Amplifier 37AR1	Amplifier-Frequency Multiplier AM-4321/GRC- 103(V).	Control-Indicator 40A4	Amplifier-Frequency Multiplier AM-43231 GRC-103(V).
Amplifier-Frequency Multiplier 38A1	Radio Set AN/GRC-103(V)3. pplier AM-43221 GRC-103(V)38	Bandpass Filter 40FL1	Amplifier-Frequency Multiplier AM-43231 GRC-103(V).
Control-Indicator 38A2	Amplifier-Frequency Multiplier AM-4322/	Electrical Dummy Load 40A1A2	Amplifier-Frequency Multiplier AM-43231 GRC-103(V).
Radio Frequency Amplifier 38AR1	GRC- 103(V).	Radio Frequency Amplifier Assembly 40A2AR2	Amplifier-Frequency Multiplier AM-43231 GRC- 103(V).
RF Power Monitor 38AR1A2	Amplifier-Frequency Multiplier AM-4322/	Branched Wiring Harness 40A1W1	Amplifier-Frequency Multiplier AM-4323/ GRC- 103(V).
Circulator 38ARIHY1	GRC- 103(V).	Circulator, 3 Port 40A1HY1	Amplifier-Frequency Multiplier AM-4323/ GRC-103(V).
Low Pass Filter 38ARIAIFL1	Amplifier-Frequency Multiplier AM-43221 GRC- 103(V).	Coaxial Isolator 40AIAT1	Amplifier-Frequency Multiplier AM-4323/ GRC- 103(V).
Electrical Dummy Load 38AR/AT1	Amplifier-Frequency Multiplier AM-43221 GRC-103(V).		
Voltage Regulator Assembly 38AR1A1A1	Amplifier-Frequency Multiplier AM-43221 GRC- 103(V).		
Amplifier-Converter AM-43191	Radio Set AN/GRC-103(V)4.		
Electronic Frequency Converter 39A2	Amplifier-Converter AM-4319/GRC-103(V).		
Frequency Multiplier 39A3	Amplifier-Converter AM-4319/GRC-103(V).		
IF. Amplifier 39AR2AR1	Amplifier-Converter AM-4319/GRC-103(V).		
Amplifier-Filter 39AR2A 1	Amplifier-Converter AM-4319/GRC-103(V).		
Radio Frequency Power Monitor 39A1AI	Amplifier-Converter AM-1319/GRC-103(V).		
Circulator, 3 Port 39AIHY1	Amplifier-Converter AM-4319/GRC- 103(V).		
Bandpass Filters 39FL1, 39FL2	Amplifier-Converter AM-4319/GRC-103(V).		
Bandpass Filter 39FL3	Amplifier-Converter AM-43191GRC-103(V).		
Control Indicator 39A4	Amplifier-Converter AM-43191GRC-103(V).		
Amplifier Radio Frequency 39AR1	Amplifier-Converter AM-43191GRC-103(V).		

b. The test setups for checking the associated AN/GRC-103(V)2, 3, and 4 assemblies are contained in TM 11-5820-540-40-1, -2 and 3. Using these test setups the following can be tested:

(1) *Case, Receiver 1A2. Wiring.*

(2) *Radio receiver 1RE1.* Dimmer switch operation 30-Megahertz (MHz) operation, 24-channel video, 12-channel video, frequency- division modulation (fdm) output level, timing pulses, pulse-code modulation (pcm) regeneration, order wire output, order wire signal-to-noise ratio, receiver squelch, pcm squelch, high signal alarm, fdm return loss, video return loss, frequency generation, local oscillator output power, video- frequency response, and metering.

(3) *Electrical frequency synthesizer 1RE1A2.* Frequency generation, sync alarm, modulation sensitivity, output power, metering and temperature compensation.

(4) *Pulse form restorer 1RE1A3.* Regeneration, pcm output level, pcm metering, timing synchronization, timing pulses, order wire level, order wire signal-to-noise ratio, order wire frequency response, and combiner order wire relay.

(5) *Electrical frequency limiter-discriminator 1RE1AR4*. Response and output level.

(6) *Amplifier-frequency multiplier 1RE1A5*. Input balance, 60-MHz rejection, maximum amplitude response, minimum passband ripple, third and fourth harmonic minimum amplitude, input and output voltage-standing wave ratio (vswr), and metering.

(7) *Video amplifier 1RE1AR1*. Gain, metering, low signal alarm, frequency response, and distortion.

(8) *Intermediate-frequency amplifier 1RE1AR2*. Gain, bandwidth, automatic gain control (agc) operation.

(9) *Bandpass filter 1RE1FL1*. Insertion loss.

(10) *Power supply 1RE1PS1*. Unregulated supply voltage, regulated supply voltages, regulation, ripple, metering, and high frequency stability.

(11) *Amplifier-Converter AM-4316/GRC-103(V)*. Noise factor input vswr protection switch, and high signal alarm.

(12) *Converter assembly 2A1A2*. Frequency-multiplier tracking, bandpass filter tracking, mixer and local oscillator filter tracking and vswr, local oscillator level monitor, and noise figure.

(13) *Frequency multiplier 2A1A2A1*. Tuning, gain, bandwidth, and vswr.

(14) *Frequency mixer stage 2A1A2A2*. Mixing operation, bandwidth, metering, and vswr of radio frequency (RF) and local oscillator inputs.

(15) *Intermediate-frequency (IF.) amplifier 2A1A2AR1*. Gain and bandwidth.

(16) *Radio frequency amplifier 2A1AR1*. Gain, bandwidth, vswr, and noise figure.

(17) *Control-indicator 2A2*. Coding and operation.

(18) *Electronic switch 2A4*. Insertion loss, vswr with switch open and closed, isolation, and switch operation.

(19) *Power supply 2PS1*. Voltages, ripple, and high signal alarm.

(20) *Case, transmitter 5A2*. Wiring.

(21) *Centrifugal fan 5A2B1*. Operation and speed.

(22) *Radio transmitter 5TR1*. Power supply operation, deviation, deviation attenuation, RF output power, frequency generation, low power alarm, sync alarm, overheat alarm, frequency response, and return losses.

(23) *Electrical frequency synthesizer 5TR1A2*. Frequency generation, sync alarm, modulation sensitivity, output power, metering, and temperature compensation.

(24) *Alarm control 5TR1A3*. Operating voltage.

(25) *Amplifier-frequency multiplier 5TR1A4*. Input vswr, bandwidth, metering, harmonics, and automatic level control operation.

(26) *Amplifier-monitor 5TR1A5*. Output level, metering, attenuator operation, and frequency response.

(27) *Power supply 5TR1PS1*. High voltage, high voltage insulation, 5-Kilo Hertz (KHz) converter risetime and frequency, 400 Hertz (Hz) inverter risetime and frequency, unregulated 26 volts, filament voltages, regulated 12 and 28 volts, metering, load regulation, input voltage regulation, high frequency stability, constant current, 5-kHz saturation, blower voltage, low-power alarm supply, 120-Hz ripple, 5-kHz spike, input current, short circuit protection, and starting circuit.

(28) *Amplifier-Frequency Multiplier AM-4320/GRC-103(V)*. Driver and power amplifier tube emissions, cathode and heater voltages, output power, tracking, and frequency selection.

(29) *Electronic switch 6A1*. Insertion loss, vswr, rejection, switch operation, and power monitoring.

(30) *Frequency multiplier assembly 6A2*. Tuning law.

(31) *Control-indicator 6A3*. Coding and operation.

(32) *Rf power level control 6A5*. Insertion and input vswr.

(33) *Receiver-Transmitter, Order Wire RT-773/GRC-103(V)*. Gain of through-paths, frequency response, distortion and crosstalk, insert and drop paths, 1, 600 Hz circuits, and handset.

(34) *Telephone signal converter 9A3*. Ringing oscillator frequency and level, ringing receiver sensitivity, and bandwidth.

(35) *Amplifier assembly 9A4*. Gain, frequency response, distortion, crosstalk, signal compression, ringing, and sidetone level.

(36) *Frequency multiplier group 33A2*. Input vswr, output power, output power, output frequency, and tracking.

(37) *Frequency multipliers 33A2A1 and 34A2A1*. Input vswr, tuning law, bandwidth, and output power.

(38) *Frequency multipliers 33A2A2 and 34A2A2*. Input vswr, output power, and harmonic rejection.

(39) *Bandpass filters 33A2FL1 and 34A2FL1*. Bandwidth and tuning law, input vswr, and insertion loss, and rejection.

(40) *Low pass filters 33A2A2FL1, 33A2A2FL2, 34A2A2FL1 and 34A2FL2*. Vswr, bandpass insertion loss, and out-of-band rejection.

(41) *Duplexer subassembly 33A1A1.* Transmitter and receiver filter vswr, and backlash, insertion loss, transmitter and receiver filter discrimination.

(42) *IF. amplifiers 33AR1 and 34AR1.* Input and output vswr, gain and agc, bandwidth, and noise figure.

(43) *Amplifier-filter 33AR1A1 and 34AR1A1.* Vswr, insertion loss and rejection.

(44) *Frequency mixer stages 33A7 and 34A7.* RF input vswr and local oscillator level metering, conversion gain and image rejection, and noise figure.

(45) *Signal level control-monitors 33A5 and 34A5.* Alarm level setting, input vswr, insertion loss, and isolation.

(46) *Low pass filter 33FL1.* Vswr, insertion loss in pass band, and out-of-band rejection.

(47) *RF power monitors 33A3, 34A3, 37AR2 and 38AR2.* Insertion loss, and power in versus voltage out.

(48) *Control-indicators 33A4, 37A2, 38A2, 39A4, and 40A4.* Control line coding.

(49) *Amplifier-Converters AM-4317()/GRC-103(V), and AM-4318()/GRC-103(V).* Functional, noise figure, receiver protection, input vswr, automatic gain control, and high signal alarm.

(50) *Frequency multiplier group 34A2.* Output power and frequency, and input vswr.

(51) *Duplexer subassembly 34A1A1.* Transmitter and receiver filter vswr, bandwidth, and backlash, transmitter and receiver filter insertion loss, RCVR SIG alinement and XMTR DUPL alinement.

(52) *Low pass filter 34FL1.* Vswr, insertion loss, and insertion loss outside of passband.

(53) *Amplifier-Frequency Multipliers AM-4321()/GRC-103(V), AM-4321A()/GRC-103(V), and AM-4322()/GRC-103(V).* Cathode and heater voltage, alc ripple, and power output and tracking.

(54) *Frequency multiplier 37A1.* Output power and tracking bandwidth, alc, and rejection.

(55) *Radio frequency amplifier 37AR1.* Filament voltage and tube current, output amplifier power output and input match, driver amplifier power output and input match, tuning and power output.

(56) *Voltage regulator assemblies 37AR1A1A1, 38AR1A1A1, and 40A3.* Driver and output regulator, driver and output line and load regulation, short circuit protection, maximum current, alc voltage, and output and driver current limiter and metering resistors.

(57) *Low pass filters 37AR1A1FL1 and 38AR1A1FL1.* Vswr, insertion loss in passband, and insertion loss outside of passband.

(58) *Amplifier-frequency multiplier 38A1.* Alc, tuning law, bandwidth, and power output, input vswr, and relay operation.

(59) *Radio frequency amplifier 38AR1.* Output and driver amplifiers power output and input match, output and driver amplifiers stability, tuning and power output, metering and alc, and output vswr.

(60) *Electrical dummy loads 38AR1AT1 and 40A1A2.* Vswr.

(61) *Circulator 38AR1HY1.* Vswr, insertion loss, and isolation.

(62) *Amplifier-Converter AM-4319()/GRC-103(V).* Receiver protection circuit, high signal alarm, noise figure, input match, duplexer-receiver section-local oscillator tracking, local oscillator drive, IF. output with a reference agc voltage, MULT metering.

(63) *3-portcirculators 39A1HY1 and 40A1HY1.* Vswr, and isolation.

(64) *Electronic frequency converter 39A3.* RF input vswr and local oscillator level metering, conversion gain and image rejection, local oscillator input vswr and noise figure, IF. output impedance and high signal alarm.

(65) *Frequency multiplier 39A3.* Tracking output power, input vswr and rejection check, input vswr, rejection of adjacent harmonics and alc.

(66) *Radio frequency amplifier 39AR1.* Input vswr, output power and output metering and alc.

(67) *IF. amplifier 39AR2.* Input and output vswr, noise figure and bandwidth.

(68) *Amplifier-filter 39AR2A1.* Vswr, insertion loss, and rejection.

(69) *Bandpass filters 39FL1, 39FL3 and 40FL1.* Insertion loss, rejection, vswr, and tuning law.

(70) *Amplifier-Frequency Multiplier AM-4323 ()/GRC-103(V).* Power output and tracking, frequency output, cathode and heater voltages, MULT metering, DRIVER, PWR OUT and REFL PWR metering.

(71) *Amplifier-frequency multiplier 40A2.* Tracking, output power, input vswr, rejection of adjacent harmonics, alc control signal, and metering.

1-10. Technical Characteristics

a. Power Requirements.

(1) *Transmitter, receiver and accessory kit, test facilities sets.*

Voltage 115 volts + 10 percent.

Frequency 47.5 to 420 Hz.

Power consumption 500 watts maximum, in use.

(2) *Radio frequency modules, test facility.*

<p><i>Source</i> Transmitter test facility</p> <p>Receiver test facility</p> <p><i>b. Temperature.</i> Operating temperature range. Non-operating temperature range.</p> <p><i>c. Altitude.</i> Maximum operating altitude. Maximum non-operating altitude.</p> <p><i>d. Humidity.</i> Maximum operating relative humidity.</p>	<p><i>Voltage</i> + 630 V dc ± 32 V dc +28Vdc ± 1.5 V dc +26 V dc ± 5.0 Vdc +12 V dc ± 1.0 Vdc -12 Vdc ± 1.0 Vdc +26 V dc ± 5.0 Vdc</p> <p>-17° C to 52° C (0° F to 125 ° F). -48° C to 68° C (-54° F to 155 ° F).</p> <p>10, 000 feet. 25, 000 feet.</p> <p>94 percent ±4.</p>	<p><i>Power consumption</i> 140 watts max. 30 watts max. 10 watts max. 5 watts max. 5 watts max. 10 watts max.</p>
---	---	--

1-11. Common Names

Nomenclatured units of the Test Facility Set AN/GRM-95(V)2 are occasionally referred by their common

names in this manual. Nomenclature and common names are listed below.

Nomenclature	Common name
<p>Test Facility Set AN/GRM-95(V)2. Panel, Test, Electrical CMC 622-800100-00. Panel, Test, Electrical CMC 622- 800028-000. Accessory Kit, Test Facilities Set MK-1173(V)2/GRM-9, Case, Test Facility, Transmitter CMC407-702/2. Case, Test Facility, Receiver CMC 407-18111. Case, Accessory Kit, CMC 407-70311. Semiconductor device assembly diode CMC 220-801225-000 Power Supply PP-6304/GRM-95(V)2. Facility, Radio Frequency Modules TS-3837(V)2/GRM-9 Accessory Kit, Test MK- 1985(V)I/GRM-95(V)2</p>	<p>Test facility set Transmitter test facility Receiver test facility Accessory kit Transmitter test facility case Receiver test facility case Accessory kit case Diode matrix Power supply 2.RF modules test facility Accessory kit, band 2, 3, and 4</p>

1-12. Description of Test Facilities Set AN/GRM-95(V)2

a The test facility set consists of five main units and seven test fixture units. Each unit is contained in a weatherproof case fitted with a carrying handle and a manually operated, two-way pressure equalizing valve. The five main units of the test facility set are:

- (1) Test Facility, Transmitter TS-2866(V)2/ GRM-95(V)2.
- (2) Test Facility, Receiver TS-2867(V)2/ GRM-95(V)2.
- (3) Accessory Kit, Test Facilities Set MK-1173(V)2/GRM-95(V)2.
- (4) Facility, Radio Frequency Modules TS-3837(V)2/GRM-95(V)2.
- (5) Accessory Kit, Test MK-1985(V)I/ GRM-95(V)2.

b. Test Facility, Transmitter TS-2866(V)2 GRM-95(V)2 consists of Case, Test Facility, Transmitter CMC 407-702/2 and Panel, Test, Electrical CMC 622-800100-000 (transmitter test facility) (fig. 1-1). The transmitter test facility mounts all the transmitter test facility controls, indicators, connectors, and the power cord for this section of the test facilities set. It is normally stored in one-half of the transmitter test facility

case as shown in figure 1- 1 and can be operated while in the case. It can also be removed and installed in a standard 19-inch relay rack. Cable assemblies, test leads, adapter-connectors, dummy loads, impedance matching networks, an airhose, and a power supply subassembly are stored in two layers in the other half of the transmitter test facility case (fig. 1-2). A location chart for the accessories is stenciled on the internal lid of the transmitter test facility case. This lid is shown closed in figure 1-1 and open in figure 1-2.

c. Test Facility, Receiver TS-2867(V)2/ GRM-95(V)2 consists of Case, Test Facility, Receiver CMC 407-181/1 and Panel, Test, Electrical CMC 622-800028-002 (receiver test facility) (fig. 1-3). The receiver test facility mounts all the receiver test facility controls, indicators, connectors, and the power cord for this section of the test facilities set. It is normally stored in one- half of the receiver test facility case as shown in figure 1-3 and can be operated while in the case. It can also be removed and installed in a standard 19-inch relay rack. Cable assemblies, adapter- connectors, dummy loads, a test lead, and an access cover plate are stored in two layers in the other half of the receiver test facility case (fig. 1-4).

A location chart for the accessories is stenciled on the internal lid of the receiver test facility case. This lid is shown closed in figure 1-3 and open in figure 1-4.

d. The transmitter and receiver test facilities each consist of a front panel and a rear chassis on which are mounted plug-in subassemblies. All connections between the front panels and rear chassis are made through three connectors. The front panels are supported and guided by slides during removal and replacement.

e. Accessory Kit, Test Facilities Set MK-1173(V)2/GRM-95(V)2 consists of Case, Accessory Kit CMC 407-703/1, Power Supply PP-6304/GRM-95(V)2, and test sets, synthesizer extension boards, dummy loads, detectors, directional coupler, fixed and variable attenuators, bandpass filters, depth gages, an impedance bridge, a return loss bridge, a double balanced mixer, a radio frequency switch, a loss pass filter, and a spare kits (fig. 1-5 and 1-6). These parts and their storage positions in the accessory kit case are identified by two stenciled location charts, one in each half of the accessory kit case. These lids are shown closed in figure 1-5 and open in figure 1-6.

f. Facility, Radio Frequency Modules TS-3837(V)2/GRM-95(V)2 consists of Case, Test Facility, Radio Frequency Modules CMC 538-800070-000 and Panel Test, Electrical- Assembly (test panel) TS-3832/GRM-95(V)2 (fig. 1-7). The RF modules test facility extends the capabilities of the transmitter and receiver test facilities, to provide testing of the subassemblies of the RF heads of Radio Set AN/GRC-103(V)2, 3, and 4. The RF modules test facility is also used in conjunction with Test Fixture Amplifier-Frequency Multiplier TS-3826/GRM-95(V)2; Test Fixture, Radio Frequency Amplifier TS-3828/GRM-95(V)2; and Test Fixture, Frequency Multiplier TS-3829/GRM-95(V)2. Power to the test panel of the RF modules test facility is supplied by the transmitter or receiver test facilities when testing modules from the transmitter or receiver RF heads respectively. Metering of the signals from modules being tested by the RF modules test facility is provided by meter M1 on the transmitter or receiver test facilities. Also required is an external 13-volt power supply which is used to power the voltage regulator section of the test panel. The test panel is normally stored in one-half of the RF modules test facility case as shown in figure 1-7, and can be operated while in the case. It can also be removed and installed in a standard 19-inch relay rack. Cable assemblies, test leads, adapter-connectors, dummy loads, attenuators, waveguide probes, an air hose and filters are stored in two layers in the other half of the

radio frequency modules test facility (fig. 1-8). A location chart for the accessories is stenciled on the internal lid of the RF modules test facility case.

g. Accessory Kit, Test MK-1985(V)1/ GRM-95(V)2 consists of Case, Accessory Kit, Test Facility CMC 538-800071-004, which contains various accessories as itemized in paragraphs 1-7 and 1-8. These accessories and their storage positions in the accessory kit case are identified by two stenciled location charts, one in each half of the accessory kit case.

h. Test Fixtures.

(1) Test Fixture, Frequency Multiplier TS-3824/GRM-95(V)2 is a mechanical jig used to test and align Frequency Multiplier SM-D-696351 (33A2A1) of Radio Set AN/GRC-103(V)2. The unit is contained in Case CMC 538-800078-000, which is used for storage and transportation purposes only. For testing, the unit is removed from its protective case.

(2) Test Fixture, Bandpass Filter CMC 617-800417-000 is a mechanical jig used to test and align Bandpass Filter SM-E-696353 (33A2FL1) of Radio Set AN/GRC-103(V)2. The unit is contained in Case CMC 538-800079-000. The case is used for storage and transportation purposes only.

(3) Test Fixture, Amplifier-Frequency Multiplier TS-3826/GRM-95(V)2 is a test stand which provides a mechanical function and also provides access for dc electrical connection to Panel, Test, Electrical Assembly TS-3832/GRM-95(V)2. This test fixture is used to test and align Frequency Multiplier SM-D-865053 (37A1) and Amplifier-Frequency Multiplier SM-E-696507 (38A1) of Radio Set AN/GRC-103(V)2, and 3 respectively. The unit is contained in Case CMC 538-800080-000 which is used for storage and transportation purposes only.

(4) Test Fixture, Bandpass Filter TS-3827/GRM-95(V)2 is a mechanical jig which is used to align and test the input vswr, bandwidth, rejection, and insertion loss following the prescribed tuning law of Filter, Bandpass SM-E-696469 (34A2FL1). Bandpass Filter 34A2FL1 is part of Radio Set AN/GRC-103(V)3. The test fixture is contained in Case CMC 538-800081-000, which is used for storage and transportation purposes only.

(5) Test Fixture, Radio Frequency Amplifier TS-3828/GRM-95(V)2 has both a mechanical and electrical function to align and test Amplifier Radio Frequency SM-E-794114 (40AR1). The mechanical function includes use as a mechanical jig as well as providing connection to the transmitter test facility in order to supply cooling air

to the unit under test. The electrical function provides cooling air to the unit under test. The electrical function provides access for dc electrical connections to Panel, Test, Electrical Assembly TS-3832/GRM-95(V)2. The test fixture is contained in Case CMC 538-800082-000.

(6) Test Fixture, Frequency Multiplier TS-3829/GRM-95(V)2 is a mechanical jig and provides access for dc and RF input electrical connection to Panel, Test, Electrical Assembly TS-3832/GRM-95(V)2. This test fixture is used to align and test both Frequency Multiplier SM-E-794075 (39A3) and Amplifier-Frequency

Multiplier SM-E-794112 (40A2) of Radio Set AN/GRC-103(V)4. The unit is contained in Case CMC 538-800083-000 which is used for storage and transportation purposes only.

(7) Test Fixture, Bandpass Filter TS-3830/GRM-95(V)2 is a mechanical jig used to align and test Filter, Bandpass SM-D-794079 (40FL1, 39FL1, and 39FL2) and Filter, Bandpass SM-D-794080 (39FL2) of Radio Set AN/GRC-103(V)4. The unit is contained in Case CMC 538-800084-000 which is used for storage and transportation purposes only.

CHAPTER 2

INSTALLION

2-1. Service Upon Receipt of Equipment

a. *Packing Data.* The units of Test Facility Set AN/GRM-95(V)2 are packed in twelve cartons. A typical packaging arrangement is shown in figure 2-1.

b. *Dimensions.* The dimensions, volumes, and weights of Test Facilities Set AN/GRM-95(V)2, when packaged for shipment, are as shown below:

Carton contents	Dimensions (in.)	Volume (cu ft)	Weight (lb)
Test Facility, Transmitter TS-2866(V)2/GRM-95(V)2.	27 X 27 X 27	11.54	144
Test Facility, Receiver TS-2867(V)2/GRM-95(V)2.	27 X 27 X 27	11.54	143
Accessory Kit, Test Facilities Set MK- 1173(V)2/GRM-95	27 X 27 X 27	11.54	139
Facility, Radio Frequency Modules TS-3837(V)2/GRM-9f	27 X 27X27	11.54	116
Accessory Kit, Test MK-1985(V) 1/GRM-95(V)2.	27 X 27 X 27	11.54	114
Test Fixture, Frequency Multiplier TS-3824/GRM-95(V)	21 X 16 X 15	2.92	32
Test Fixture, Amplifier Frequency Multiplier TS-3826/GRM-95(V)2.	21 X 15 X 15	2.74	30
Test Fixture, Radio Frequency, Amplifier TS-3828/GRM	23 X 17 X 15	3.38	38
Test Fixture, Frequency Multiplier TS-3829/GRM-95(V)	24 X 18 X 15	3.75	36
Test Fixture, Bandpass Filter TS-3830/GRM-95(V)2.	24 X 18 X 15	3.75	36
Test Fixture, Bandpass Filter TS-3835(V)/GRM-95(V)2.	24 X 18 X 15	3.75	40
Test Fixture, Bandpass Filter TS-3827/GRM-95(V)2.	21 X 15 X 15	2.74	31

2-2. Checking Unpacked Equipment

a. Inspect the equipment for damage which may have occurred during shipment. If the equipment has been damaged, fill out and forward SF 364 (para 1-3b.).

b. Check to see that the equipment is complete as listed on the packing slip. Report all discrepancies in accordance with AR 735-11-2. The equipment should be placed in service even though a minor assembly or part that does not affect proper functioning is missing.

c. Check to see whether the equipment has been modified. If the equipment has been modified, the MWO number will appear on the front panel, near the nomenclature plate. Check also to see whether all MWO's current at the time the equipment is placed in use have been applied.

NOTE

Current MWO's applicable to the equipment are listed in DA Pam 310-1.

d. Check the latest issue of DA Pam 310-1 (never more than 1 year old) and its latest changes (never more than 6 months old) to see whether you have the latest edition of all applicable maintenance literature.

2-3. Installation Instructions

The units of the test facilities set, except the test fixtures, may be used either mounted in their cases, or mounted on standard 19-inch racks.

a. When the units are to be used in their cases, place the cases on a suitable workbench or any solid flat surface.

b. Rack-mount the units as follows:

(1) Remove the screws securing the transmitter test facility (fig. 1-1) to the case. Remove the unit

(2) Remove the screws securing the receiver from the case. test facility (fig.1-2) to the case. Remove the unit

(3) Remove the screws securing power supply from the case. 407-192 to the accessory kit case (fig. 1-3). Remove the unit from the case.

(4) Mount the units on standard 19-inch racks.

(5) Remove the screws securing the radio frequency modules test facility test panel (fig. 1-7) to the case. Remove the unit from the case.

(6) Mount the unit on a standard 19-inch rack.

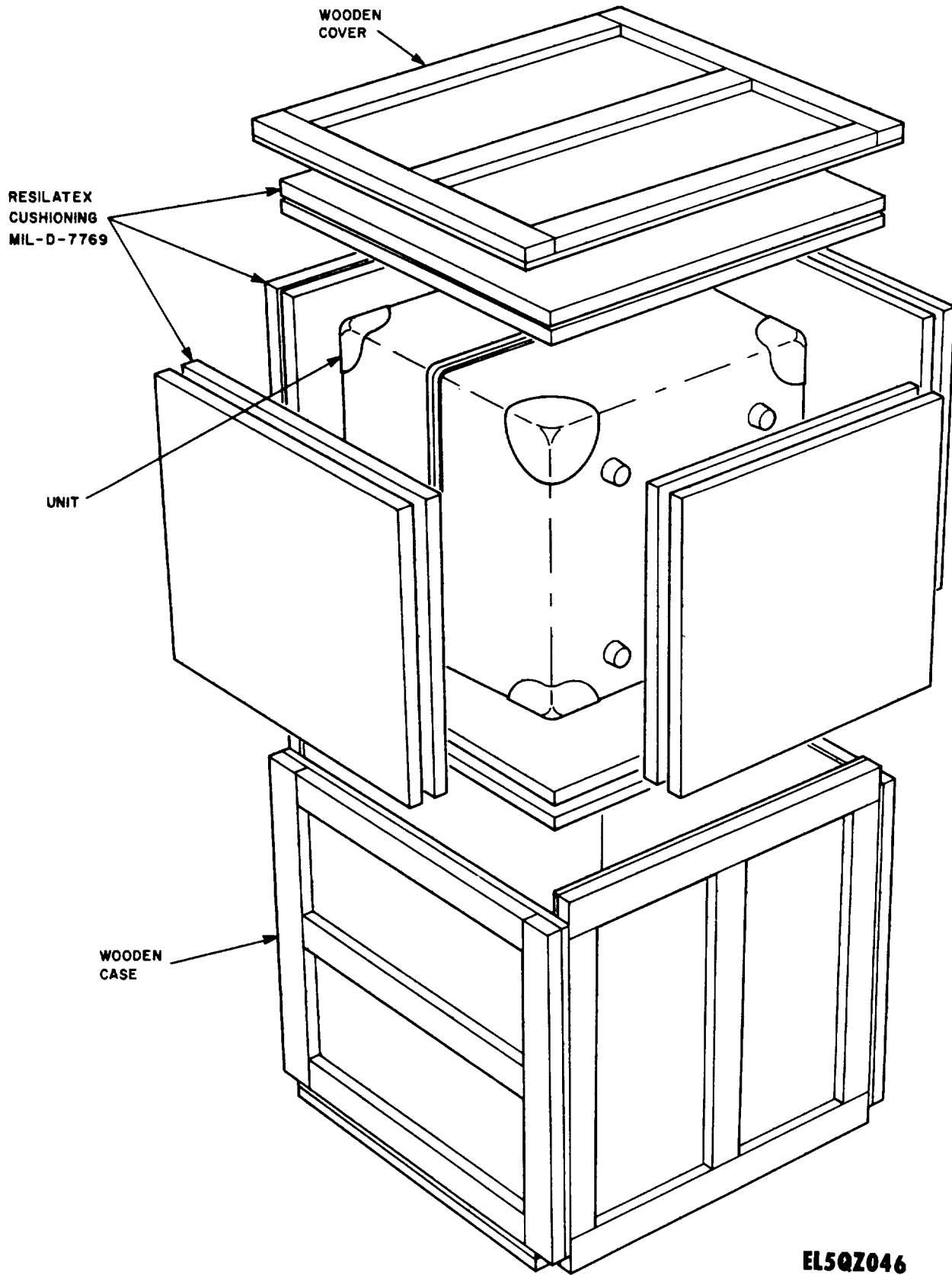

EL5QZ046

Figure 2-1. Typical Packaging of Test Facility Set AN/GRM-95(V)2.

**CHAPTER 3
OPERATING INSTRUCTIONS**

**Section I. TEST FACILITY, TRANSMITTER
TS-2866(V)2/GRM-95(V)2 CONTROLS, INDICATORS, FUSES,
AND CONNECTORS**

3-1. General (fig. 3-1)

The transmitter test facility controls, indicators, fuses, and connectors are listed, with their functions, in paragraphs 3-2 through 3-17. Throughout this section, the AN/GRC-103(V) assembly under test is referred to

as AUT.

3-2. POWER Section Control and Indicators

Control or indicator	Function
Switch S1	Set to ON, connects ac power to transmitter test facility. Set to OFF, disconnects ac power from transmitter test facility. Provides circuit breaker protection at 5-ampere rating.
AC indicator	Lights when ac power is connected to transmitter test facility.
+ 12 V indicator	Lights when internal + 12 volt dc supply is operating.
+ 28 V indicator	Lights when internal + 28 volt dc supply is operating.

3-3. 26V SUPPLY Section Control, Indicator, Fuses, and Connectors

Control, indicator, fuse, or connector	Function
Switch S6	Set to ON, connects dc voltages to J59 and J14. Set to OFF, removes dc voltages from J59 and J14.
Indicator	Lights when 6 volt and 26 volt dc supplies are on.
3A FUSE	Protects 26 volt dc supply at J14.
SPARE FUSE	Hold spare 3 ampere fuse.
Connector J59 6 V 10 ma	Provides 6 volt dc maximum current 10 ma, for use in external test setups.
Connector J 13 COM	Provide 6 volt and 26 volt neutral return when S6 is set to ON.
Connector J 14 + 26 V	Provides 26 volts dc for use in external test setups.

3-4. METERING Section Control and Indicator

Control, indicator, fuse, or connector	Function																						
Meter M1	Indicates levels of internal power supply voltages and levels from transmitter tests facility sections.																						
Switch S20 (15-position rotary switch)	Connects meter M1 to internal power supply voltages or to transmitter test facility test sections.																						
	<table border="0"> <tr> <td><i>Sw pos</i></td> <td><i>Meter Indicator</i></td> </tr> <tr> <td>S4</td> <td>Level from S4 section.</td> </tr> <tr> <td>S12</td> <td>Levels from S12 section.</td> </tr> <tr> <td>S17</td> <td>Levels from S17 section.</td> </tr> <tr> <td>S21</td> <td>Levels from S21 section.</td> </tr> <tr> <td>S26</td> <td>Levels from S26 section.</td> </tr> <tr> <td>S28</td> <td>Levels from S28 section.</td> </tr> <tr> <td>S30</td> <td>Levels from S30 section.</td> </tr> <tr> <td>30 MHz DISCR.....</td> <td>RF level in discriminator.</td> </tr> <tr> <td>+ 12 V</td> <td>+ 12 volt dc supply voltage.</td> </tr> <tr> <td>+ 28 V</td> <td>+ 28 volt dc supply voltage.</td> </tr> </table>	<i>Sw pos</i>	<i>Meter Indicator</i>	S4	Level from S4 section.	S12	Levels from S12 section.	S17	Levels from S17 section.	S21	Levels from S21 section.	S26	Levels from S26 section.	S28	Levels from S28 section.	S30	Levels from S30 section.	30 MHz DISCR.....	RF level in discriminator.	+ 12 V	+ 12 volt dc supply voltage.	+ 28 V	+ 28 volt dc supply voltage.
<i>Sw pos</i>	<i>Meter Indicator</i>																						
S4	Level from S4 section.																						
S12	Levels from S12 section.																						
S17	Levels from S17 section.																						
S21	Levels from S21 section.																						
S26	Levels from S26 section.																						
S28	Levels from S28 section.																						
S30	Levels from S30 section.																						
30 MHz DISCR.....	RF level in discriminator.																						
+ 12 V	+ 12 volt dc supply voltage.																						
+ 28 V	+ 28 volt dc supply voltage.																						

3-4. METERING Section Control and Indicator-Continued

Control, indicator, fuse, or connector	Function
S26 V.....	+ 26 volt dc supply voltage.
OUTPUT FIL.....	Voltage of output tube filament supply.
DRIVER FIL.....	Voltage of driver tube filament supply.
26 V AC	26 volt ac supply voltage.
+600 V.....	+600 volt dc supply voltage.

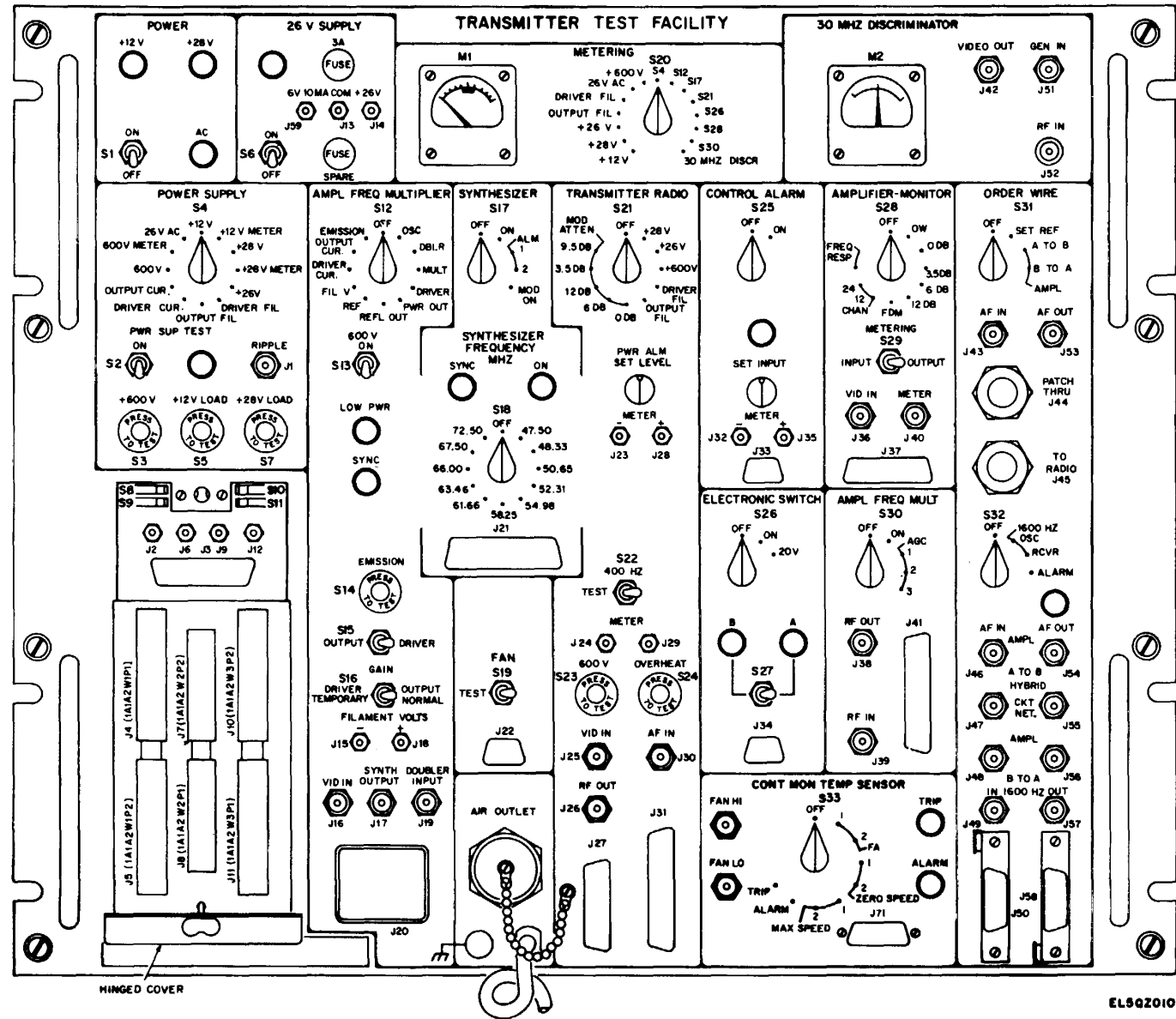

EL502010

Figure 3-1. Transmitter Test Facility, Front panel.

3-5. 30 MHz DISCRIMINATOR Section Indicator, and Connectors

Control, indicator, fuse, or connector	Function
Meter M2 Connector J42 VIDEO OUT Connector J61 GEN IN Connector J52 RF IN	Center zero movement; indicates from 29.7 MHz to 30.3 MHz. Connection from discriminator output. Low level signal connection to double balanced mixer 280-990034-842 LO input. High level signal connection through 1 watt, 10 dB attenuator to double balanced mixer 280-990034-842 RF input.

3-6. POWER SUPPLY Section Controls, Indicator, and Connectors

Control, indicator, fuse, or connector	Function																										
PWR SUP TEST switch S2 PWR SUP TEST indicator Switch S4 (12-position rotary switch)	Set to ON, connects ac power, through J3, to AUT. Set to off, removes ac power from AUT. Lights when S2 is set to ON. Connects J1, and meter MI through S20, to AUT.																										
Connector J 1 RIPPLE Switch S3 +600 V Switch S5 + 12 V LOAD Switch S7 + 28 V LOAD Hinged cover, OPEN ONLY FOR POWER SUPPLY TESTS. Interlock switches S8, S9 Interlock switches S0, S 11 Connector J2 Connector J6. Connector J9 Connector J12 Connector J3 Connectors J5, J7, and J8. Cable assembly 457-584. Cable assembly 457-585. Cable assembly 457-586.	<table border="0"> <tr> <td><i>Sw pos</i></td> <td><i>Meter indication</i></td> </tr> <tr> <td>+12 V</td> <td>+12 volt dc supply voltage.</td> </tr> <tr> <td>+12 V METER</td> <td>+ 12 volt dc supply metering voltage.</td> </tr> <tr> <td>+28 V</td> <td>+28 volt dc supply voltage.</td> </tr> <tr> <td>+28V</td> <td>+ 28 volt dc supply metering voltage.</td> </tr> <tr> <td>+26V</td> <td>+26 volt dc supply voltage.</td> </tr> <tr> <td>DRIVER FIL</td> <td>Driver tube filament supply voltage.</td> </tr> <tr> <td>OUTPUT FIL</td> <td>Output tube filament supply voltage.</td> </tr> <tr> <td>DRIVER CUR</td> <td>Driver tube filament supply current.</td> </tr> <tr> <td>OUTPUT CUR</td> <td>Output tube filament supply current.</td> </tr> <tr> <td>600 V</td> <td>600 Volt DC supply voltage.</td> </tr> <tr> <td>600 V METER</td> <td>+600 volt dc supply metering.</td> </tr> <tr> <td>26 V AC</td> <td>26 volt ac supply voltage.</td> </tr> </table> <p>Connection to AUT ripple voltages through S4 positions + 12 V, + 28 V, + 26 V, DRIVER FIL, OUTPUT FIL, DRIVER CUR, OUTPUT CUR, and 600 V. Pressed and held, while switching S2 off and ON, to switch on AUT 600 volt dc supply. Pressed and held to load AUT + 12 volt dc supply. Pressed and held to load AUT + 28 volt dc supply. Closed for normal operation. Opened to connect test facility to power supply subassemblies under test. Disconnect ac power input to internal power supply when hinged cover is open. Disconnect power to internal fan when hinged cover is open. Connection to chassis ground. Connection to + 12 volt supply from AUT at J3. Connection to + 26 volt supply from AUT at J3. Connection to +S28 volt supply from AUT at J3. Connects AUT to internal dummy loads and metering circuits. Connect test facility to assemblies under test. Connects J4 to J5 for normal operation. Connects J7 to JS for normal operation. Connects J10 to J 11 for normal operation.</p>	<i>Sw pos</i>	<i>Meter indication</i>	+12 V	+12 volt dc supply voltage.	+12 V METER	+ 12 volt dc supply metering voltage.	+28 V	+28 volt dc supply voltage.	+28V	+ 28 volt dc supply metering voltage.	+26V	+26 volt dc supply voltage.	DRIVER FIL	Driver tube filament supply voltage.	OUTPUT FIL	Output tube filament supply voltage.	DRIVER CUR	Driver tube filament supply current.	OUTPUT CUR	Output tube filament supply current.	600 V	600 Volt DC supply voltage.	600 V METER	+600 volt dc supply metering.	26 V AC	26 volt ac supply voltage.
<i>Sw pos</i>	<i>Meter indication</i>																										
+12 V	+12 volt dc supply voltage.																										
+12 V METER	+ 12 volt dc supply metering voltage.																										
+28 V	+28 volt dc supply voltage.																										
+28V	+ 28 volt dc supply metering voltage.																										
+26V	+26 volt dc supply voltage.																										
DRIVER FIL	Driver tube filament supply voltage.																										
OUTPUT FIL	Output tube filament supply voltage.																										
DRIVER CUR	Driver tube filament supply current.																										
OUTPUT CUR	Output tube filament supply current.																										
600 V	600 Volt DC supply voltage.																										
600 V METER	+600 volt dc supply metering.																										
26 V AC	26 volt ac supply voltage.																										

3-7. AMPL FREQ MULTIPLIER Section Controls, Indicators, and Connectors

Control, indicator, fuse, or connector	Function
Switch S12 (12-position rotary switch).....	Connects dc power to internal synthesizer, diode semiconductor matrix, and frequency multiplier, and to AUT. Connects AUT metering voltages to meter M1 through S20, position S12. Connects dc power to radio frequency modules test facility through J20.

3-7. AMPL FREQ MULTIPLIER Section Controls, Indicators, and Connectors-Continued

Control, indicator, fuse, or connector	Function
	<p>Sw pos Meter indication</p> <p>OSC..... Output of internal synthesizer.</p> <p>DBLR..... Output of internal frequency multiplier.</p> <p>MULT..... Output of frequency multiplier in AUT.</p> <p>DRIVER..... Output of driver tube in AUT.</p> <p>PWR OUT..... RF output of AUT.</p> <p>REFL OUT..... Reflected power at output of AUT.</p> <p>REF Filament reference voltage, through S15, for driver or output tube in AUT.</p> <p>FIL V Filament voltage at J15 and J18 from AUT.</p> <p>DRIVER CUR..... Drive tube cathode bias in AUT.</p> <p>OUTPUT CUR..... Output tube cathode bias in AUT.</p> <p>EMISSION..... Cathode current, through S15, from AUT when S14 is pressed and held.</p> <p>OFF..... Disconnects all power from AMPL FREQ MULTIPLIER section.</p>
Switch S13 LOW PWR indicator	When set to ON, connect 600 volt dc supply to AUT. Lights when RF output of AUT falls below 3 watts. Goes out when RF output of AUT rises above 5.5 watts.
SYNC indicator..... Switch S14 EMISSION test.....	Lights when internal synthesizer has fault condition. Press and hold on meter M1 for approximately 20 seconds to indicate the cathode current of tube in AUT selected by S15.
Switch S 15	Connects driver or output tube in AUT, through S14, to S12 position EMISSION or REF.
Switch S16 GAIN..... Connectors J15-, J18+ FILAMENT VOLTS..... S12	Used in the alinement of AUT. Connection to AUT: meter M1 indicates filament voltage through switch position FIL V.
Connectors J16 VID IN. Connector J17 SYNTH OUTPUT. Connector J19 DOUBLER INPUT	Connection to modulation input of internal synthesizer. Connection from internal synthesizer output. Connection to input of internal frequency doubler which drives AUT.
Connect J20	Connects transmitter test facility to AUT. Connects meter M 1 and dc power to radio frequency module test facility.

3-8. SYNTHESIZER Section Controls, Indicators, and Connector

Control, indicator, fuse, or connector	Function
Switch S17 (5-position rotary switch).	Connects dc power to AUT and oscillator metering voltage to meter M through S20, position S17.
	<p>Sw pos Function</p> <p>ON..... Connects dc power to AUT.</p> <p>ALM 1..... With S18 set to position 48.33, AUT programmed for high frequency alarm; meter M1 indication will vary and SYNC lamp will light.</p> <p>ALM 2..... With S18 set to position 48.33, AUT programmed for low frequency alarm; meter M1 indication will vary and SYNC lamp will light.</p> <p>MOD ON..... Connects 1 kHz signal from internal oscillator to AUT.</p> <p>OFF..... Remove dc power from AUT.</p>
SYNC indicator..... ON indicator	Lights when AUT has fault condition. Lights when S 18 is at any position other than off.
Switch S18	Programs internal synthesizer and AUT for the output frequencies shown.
Connector J21	Connects transmitter test facility to AUT.

3-9. FAN Section Control and Conector

Control, indicator, fuse, or connector	Function
Switch S19	In TEST position, disconnects power from internal fan and applies power to AUT.
Connector J22	Connects transmitter test facility to AUT.

3-10. AIR OUTLET Section Connector

When the screwed cap is removed, forced air cooling from the internal fan is supplied. The forced air can be routed from the AIR OUTLET through the hose assembly air duct (3, fig. 1-2) to AUT.

3-11. TRANSMITTER RADIO Section Controls and Connectors

Control, indicator, fuse, or connector	Function
Switch S21 (11 -position rotary switch).....	Connects ac power to AUT. Connects METERING section to power supply voltages in AUT. Tests modulation path attenuation in AUT.
Sw pos	Function
+ 28 V	Meter M1 indicates voltage of + 28 volt dc supply in AUT.
+26V	Meter M1 indicates voltage of +28 volt dc supply in AUT.
+600V	Meter M1 indicates voltage of +600 volt dc supply in AUT.
DRIVER FIL	Meter M1 indicates driver tube filament voltage in AUT.
OUTPUT FIL	Meter M1 indicates output tube filament voltage in AUT.
0 DB	Inserts 0 dB attenuation in modulation path in AUT.
6DB	Inserts 6 dB attenuation in modulation path in AUT.
12 DB.....	Inserts 12 dB attenuation in modulation path in AUT.
3.5 DB.....	Inserts 3.5 dB attenuation in modulation path in AUT.
9.5 DB.....	Inserts 9.5 dB attenuation in modulation path in AUT.
OFF	Removes ac power from AUT.
PWR ALM SET LEVEL control.....	Adjusts dc signal level to control alarm in AUT.
Connectors J23- and J28+	Metering points for dc signal to control alarm in AUT.
Switch S22 400 Hz r -pr4-loded).....	In TEST position, loads 128 volt, 400 Hz supply in AUT and connects one-tenth of voltage to J24 and J29.
Connectors J24 and J29	Metering points for 400 Hz supply from AUT when S22 is operated.
Switch 823 600 V	Pressed and held to indicate on meter M1 voltage of 600 volt supply from AUT through switch S21 +600 V position.
Switch S24 OVERHEAT.....	Pressed and held to test overheat indicator on AUT.
Connector J26 VID IN	Connects video modulation signal to AUT.
Connector J30 AF IN.....	Connects order wire modulation signal to AUT.
Connector J27 and JS1	Connect transmitter test facility to AUT.

3-12. CONTROL ALARM Section Controls, Indicator, and Connectors

Control, indicator, fuse, or connector	Function
Switch S25	In ON position, connects power and variable alarm signal to AUT.
Alarm indicator	Lights when AUT is in alarm condition.
SET INPUT control	Adjusts level of alarm signal to AUT.
Connectors J32 and J35	Metering points for alarm signal to AUT.
Connector J33	Connects transmitter test facility to AUT.
Switch S26	Connects dc power to AUT, and metering voltages to meter M1 through S20, position S26.
	<i>Sw pos</i> <i>Function</i>
	OFF Removes dc power from AUT.
	ON..... Connects + 26 volts dc to AUT.
	20 V Connects +20 volts dc to AUT.
Indicator A	Lights when AUT is set to times-2 multiplication path.
Indicator B	Lights when AUT is set to times-3 multiplication path.
Switch S27	Position A sets AUT to times-2 multiplication path.
Connector J34	Connects transmitter test facility to AUT.

3-14. AMPLIFIER-MONITOR Section Controls and Connectors

Control, indicator, fuse, or connector	Function
Switch S28 (10-position rotary switch).....	Connects power to AUT; operates attenuators in AUT; connects meter M1 to metering voltages from AUT; connects J36 to AUT; loads video input to AUT with 51 ohms.
	<i>Sw pos</i> <i>Function</i>
	OW Connects J36 to order wire input of AUT.
	0 DB Bypasses attenuation in signal path in AUT.
	3.5 DB..... Inserts 3.6 dB attenuation in signal path in AUT.
	6DB Inserts 6 dB attenuation in signal path in AUT.
	12 DB..... Inserts 12 dB attenuation in signal path in AUT.
	FDM..... Connects meter M1 to fdm metering voltage from AUT.
	12 CHAN..... Connects meter M1 to 12-channel pcm metering voltage from AUT.
	24 CHAN..... Connects meter M1 to 24-channel pcm metering voltage from AUT.
	FREQ RESP Connects compensating network between J36 and AUT.
	OFF Disconnects power and J36 from AUT.
Switch S29 METERING	OUTPUT position connects J40 to output of AUT. INPUT position connects J40 to J36.
Connector J36 VID IN	Provides connection to input of AUT.
Connector J40 METER	Provides meter connection through 29.
Connector J37	Connects transmitter test facility to AUT.

3-15. AMPL FREQ MULT Section Control and Connectors

Control, indicator, fuse, or connector	Function
Switch S30 (5-position rotary switch)	Connects power and three gain control voltages to AUT. Connects meter M 1 to RF power metering voltage from AUT.
<i>Sw pos</i>	<i>Function</i>
ON	Connects power and 0 volt gain control signal to AUT.
AGC 1	Connects 8.1 volt gain control signal to AUT.
AGC 2	Connects 8.7 volt gain control signal to AUT.
AGC 2	Connects 8.7 volt gain control signal to AUT.
AGC 3	Connects 8.9 volt gain control signal to AUT.
OFF	Removes power from AUT.
Connector J38 RF OUT	Connection from RF output of AUT.
Connector J39 RF IN	Connection to RF input of AUT.
Connector J41	Connects transmitter test facility to AUT.

3-16. ORDER WIRE Section Controls, Indicator, and Connectors

Control, indicator, fuse, or connector	Function
Switch S31 (4-position rotary switch)	Connects power to AUT. Connects J43 and J53 to A TO B and B TO A amplifiers in AUT.
<i>Sw pos</i>	<i>Function</i>
SET REF	Connects J43 to J53.
AMPL A TO B	Connects J43 to receiver A input and J53 to transmitter B output of AUT.
AMPL B TO A	Connects J43 to receiver B input and J53 to transmitter A output of AUT.
OFF	Removes power from AUT.
Connector J43 AF IN	Audio frequency connection to J53 or AUT through S31.
Connector J53 AF OUT	Audio frequency connection from J43 or AUT through S31.
Connectors 44, PATCH THRU, and J45 TO RADIO.	Connect transmitter test facility to AUT.
Switch S32 (4-position rotary switch)	Connects power to J50 and J58. Connects J58 for 1, 600 Hz oscillating or receiving mode.
1600 Hz OSC	Connects J57 to J58 and connect AUT for oscillating mode.
1600 Hz RCVR	Connects J57 to J58 and connects AUT for amplifying mode.
ALARM	Connects alarm indicator to J58 AUT.
OFF	Removes power from J50 and J58.
ALARM indicator	Lights when 1, 600 Hz ringing tone is applied to J58 AUT.
Connector J46 AF IN AMPL A TO B	Connection to receiver A input of J50.
Connector J54 AF OUT AMPL A TO B	Connection to transmitter B output of J50.
Connector J47 HYBRID CKT NET	Connection to mike input of J50.
Connector J55 HYBRID CKT NET	Connection to phone output of J50.
Connector J48 AMPL B TO A	Connection to receiver B input to J50.
Connector J56 AMPL B TO A	Connection to transmitter A output of J50.
Connector J49 1600 Hz IN	Connection to 1, 600 Hz inputs of J50 and J58 AUT.
Connector J57 1600 Hz OUT	Connection to 1, 600 Hz output of J50 and to J58 through S32, positions 1600 Hz OSC and RCVR.
Connector J50	Connects transmitter test facility to ATU.
Connector J58	Connects transmitter test facility to AUT.

3-17. CONT MON TEMP SENSOR Section Controls, Indicators, and Connectors

Control, indicator, fuse, or connector	Function																				
Switch S33 (12-position rotary switch.....	When switched away from OFF position, connects + 26 V dc and resistive loads to AUT, and 128 V 400 Hz is routed through AUT to internal fan.																				
	<table border="0"> <thead> <tr> <th data-bbox="704 384 997 415"><i>Sw pos</i></th> <th data-bbox="997 384 1547 415"><i>Function</i></th> </tr> </thead> <tbody> <tr> <td data-bbox="704 415 997 468">FAIL 1</td> <td data-bbox="997 415 1547 468">Connects a 2 megohm resistor across the input of AUT.</td> </tr> <tr> <td data-bbox="704 468 997 520">FAIL 2</td> <td data-bbox="997 468 1547 520">Connects a short circuit across the input of AUT.</td> </tr> <tr> <td data-bbox="704 520 997 573">ZERO SPEED 1</td> <td data-bbox="997 520 1547 573">Connects a 301 ohm resistor across the input of AUT.</td> </tr> <tr> <td data-bbox="704 573 997 625">ZERO SPEED 2</td> <td data-bbox="997 573 1547 625">Connects a 7.5 kilohm resistor across the input of AUT.</td> </tr> <tr> <td data-bbox="704 625 997 678">MAX SPEED 1</td> <td data-bbox="997 625 1547 678">Connects a 2.05 kilohm resistor across the input of AUT.</td> </tr> <tr> <td data-bbox="704 678 997 730">MAX SPEED 2</td> <td data-bbox="997 678 1547 730">Connects a 825 ohm resistor across the input of AUT.</td> </tr> <tr> <td data-bbox="704 730 997 783">ALARM</td> <td data-bbox="997 730 1547 783">Connects a 536 ohm resistor across the input of AUT.</td> </tr> <tr> <td data-bbox="704 783 997 835">TRIP</td> <td data-bbox="997 783 1547 835">Connects a 395 ohm resistor across the input of AUT.</td> </tr> <tr> <td data-bbox="704 835 997 940">OFF</td> <td data-bbox="997 835 1547 940">Removes power from AUT and connects 128 V 400 Hz supply directly to internal fan.</td> </tr> </tbody> </table>	<i>Sw pos</i>	<i>Function</i>	FAIL 1	Connects a 2 megohm resistor across the input of AUT.	FAIL 2	Connects a short circuit across the input of AUT.	ZERO SPEED 1	Connects a 301 ohm resistor across the input of AUT.	ZERO SPEED 2	Connects a 7.5 kilohm resistor across the input of AUT.	MAX SPEED 1	Connects a 2.05 kilohm resistor across the input of AUT.	MAX SPEED 2	Connects a 825 ohm resistor across the input of AUT.	ALARM	Connects a 536 ohm resistor across the input of AUT.	TRIP	Connects a 395 ohm resistor across the input of AUT.	OFF	Removes power from AUT and connects 128 V 400 Hz supply directly to internal fan.
<i>Sw pos</i>	<i>Function</i>																				
FAIL 1	Connects a 2 megohm resistor across the input of AUT.																				
FAIL 2	Connects a short circuit across the input of AUT.																				
ZERO SPEED 1	Connects a 301 ohm resistor across the input of AUT.																				
ZERO SPEED 2	Connects a 7.5 kilohm resistor across the input of AUT.																				
MAX SPEED 1	Connects a 2.05 kilohm resistor across the input of AUT.																				
MAX SPEED 2	Connects a 825 ohm resistor across the input of AUT.																				
ALARM	Connects a 536 ohm resistor across the input of AUT.																				
TRIP	Connects a 395 ohm resistor across the input of AUT.																				
OFF	Removes power from AUT and connects 128 V 400 Hz supply directly to internal fan.																				
TRIP indicator.....	Lights when S33 in FAIL 2 and TRIP positions. Indicates the simulation of removal of high voltage from radio transmitter output tubes because of overheat condition.																				
ALARM	Lights when S33 in FAIL 1, FAIL2, ALARM and TRIP positions.																				
.....	Indicates simulated fault conditions approaching TRIP level action.																				
Connector J69 FAN HI	Monitor point for 400 Hz HI signal from AUT.																				
Connector J70 FAN LO	Monitor point for 400 Hz LO signal from AUT.																				
Connector J71	Connector test panel to AUT.																				

**Section II. TEST FACILITY, RECEIVER TS-2876(V)2/GRM-95(V)2
CONTROLS, INDICATORS, AND CONNECTORS**

3-18. General (fig. 3-2)

The receiver test facility controls, indicators, and connectors are listed, with their functions, in paragraphs

3-19 through 3-30. Throughout this section, the AN/GRC-103(V) assembly under test is referred to as AUT.

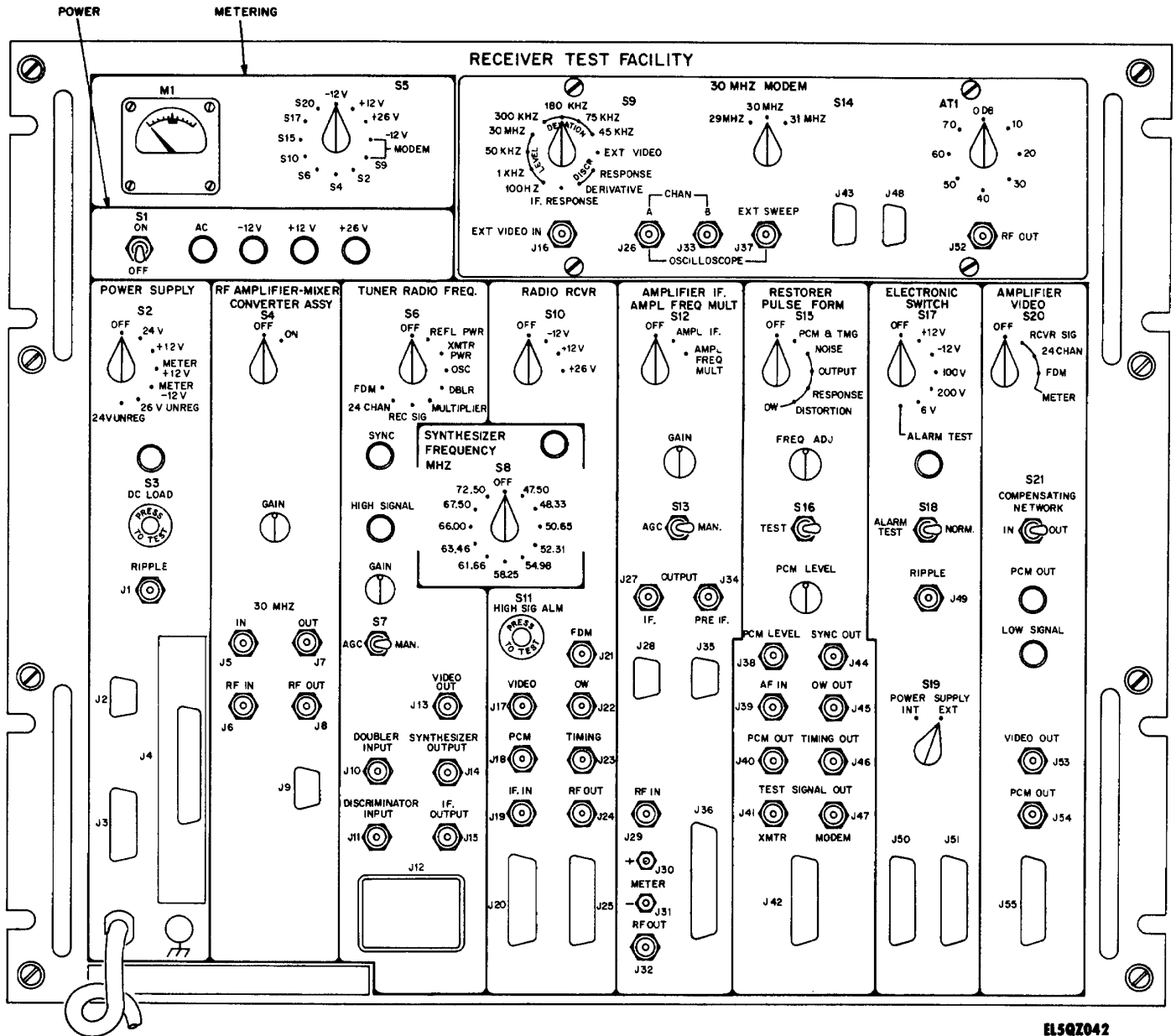

EL5QZ042

Figure 3-2. Receiver Test Facility, Front Panel.

3-19. Metering Section Control and Indicator

Controls/indicators	Function																										
Meter M1.....	Indicates levels of internal power supply voltages and levels from receiver test facility test sections.																										
Switch S5 (12-position rotary switch).....	Connects meter M1 to internal power supply voltages or receiver test facility test sections.																										
	<table border="0"> <thead> <tr> <th data-bbox="857 298 941 325"><i>Sw pos</i></th> <th data-bbox="1143 298 1240 325"><i>Function</i></th> </tr> </thead> <tbody> <tr> <td data-bbox="711 325 836 357">-12 V</td> <td data-bbox="1045 325 1331 357">-12 volt dc supply voltage.</td> </tr> <tr> <td data-bbox="711 357 836 388">+12 V</td> <td data-bbox="1045 357 1331 388">+12 vot dc supply vorage.</td> </tr> <tr> <td data-bbox="711 388 836 420">+26 V</td> <td data-bbox="1045 388 1331 420">+26 volt dc supply voltage.</td> </tr> <tr> <td data-bbox="711 420 836 472">-12 V MODEM</td> <td data-bbox="1045 420 1331 472">Voltage of modem - 12 volt dc power supply.</td> </tr> <tr> <td data-bbox="711 472 836 504">S9 MODEM</td> <td data-bbox="1045 472 1218 504">Levels from S9.</td> </tr> <tr> <td data-bbox="711 504 836 535">S2.....</td> <td data-bbox="1045 504 1218 535">Levels from S2.</td> </tr> <tr> <td data-bbox="711 535 836 567">S4</td> <td data-bbox="1045 535 1218 567">Levels from S4.</td> </tr> <tr> <td data-bbox="711 567 836 598">S6</td> <td data-bbox="1045 567 1218 598">Levels from S6.</td> </tr> <tr> <td data-bbox="711 598 836 630">S10 ..</td> <td data-bbox="1045 598 1218 630">Levels from S10.</td> </tr> <tr> <td data-bbox="711 630 836 661">S15 ..</td> <td data-bbox="1045 630 1218 661">Levels from S15.</td> </tr> <tr> <td data-bbox="711 661 836 693">S17 ..</td> <td data-bbox="1045 661 1218 693">Levels from S17</td> </tr> <tr> <td data-bbox="711 693 836 724">S20</td> <td data-bbox="1045 693 1218 724">Levels from S20</td> </tr> </tbody> </table>	<i>Sw pos</i>	<i>Function</i>	-12 V	-12 volt dc supply voltage.	+12 V	+12 vot dc supply vorage.	+26 V	+26 volt dc supply voltage.	-12 V MODEM	Voltage of modem - 12 volt dc power supply.	S9 MODEM	Levels from S9.	S2.....	Levels from S2.	S4	Levels from S4.	S6	Levels from S6.	S10 ..	Levels from S10.	S15 ..	Levels from S15.	S17 ..	Levels from S17	S20	Levels from S20
<i>Sw pos</i>	<i>Function</i>																										
-12 V	-12 volt dc supply voltage.																										
+12 V	+12 vot dc supply vorage.																										
+26 V	+26 volt dc supply voltage.																										
-12 V MODEM	Voltage of modem - 12 volt dc power supply.																										
S9 MODEM	Levels from S9.																										
S2.....	Levels from S2.																										
S4	Levels from S4.																										
S6	Levels from S6.																										
S10 ..	Levels from S10.																										
S15 ..	Levels from S15.																										
S17 ..	Levels from S17																										
S20	Levels from S20																										

3-20. Power Section Control and Indicators

Controls/indicators	Function
Switch S1.....	Set to ON, connects ac power to receiver test facility. Set to OFF, disconnects ac power from receiver test facility. Provides circuit breaker protection at 1ampere rating.
AC indicator.....	Lights when ac power is connected to receiver test facility.
- 12 V indicator.....	Lights when internal -12 volt dc supply is operating.
+ 12 V indicator.....	Lights when internal + 12 volt d supply is operating.
+ 26 V indicator.....	Lights when internal + 26 volt dc supply is operating.

3-21. 30 MHz Controls and Connectors

Controls/indicators	Function																								
Switch S9(12-posion rotary switch one position unused)). J43, J48 in response or derivative modes.	<p>Connects oscillator metering voltages to meter M1 through S5 position S9.</p> <p>Controls deviation of RF output. Connects internal limiter discriminator and</p>																								
Switch S14 Attenuator AT1 Connector J16 EXT VIDEO IN Connector J26 CHAN A Connector J33 CHAN B Connector J37 EXT SWEEP Connectors J43 and J48 Connector J52 RF OUT	<table border="0"> <thead> <tr> <th data-bbox="857 1249 941 1276"><i>Sw pos</i></th> <th data-bbox="1143 1249 1240 1276"><i>Function</i></th> </tr> </thead> <tbody> <tr> <td data-bbox="711 1276 836 1308">100 Hz</td> <td data-bbox="1045 1276 1502 1308">Meter M1 indicates 100 Hz sawtooth level.</td> </tr> <tr> <td data-bbox="711 1308 836 1339">1 KHz</td> <td data-bbox="1045 1308 1502 1339">Meter M1 indicates 1 kHz oscillator level.</td> </tr> <tr> <td data-bbox="711 1339 836 1371">50 KHz</td> <td data-bbox="1045 1339 1502 1371">Meter M1 indicates 50 kHz oscillator level.</td> </tr> <tr> <td data-bbox="711 1371 836 1402">30 MHz</td> <td data-bbox="1045 1371 1502 1402">Meter M1 indicates 30 MHz signal level.</td> </tr> <tr> <td data-bbox="711 1402 836 1434">300 KHz</td> <td data-bbox="1045 1402 1421 1434">Deviates RF output 300 kHz peak.</td> </tr> <tr> <td data-bbox="711 1434 836 1465">180 KHz</td> <td data-bbox="1045 1434 1421 1465">Deviates RF output 180 kHz peak.</td> </tr> <tr> <td data-bbox="711 1465 836 1497">75 KHz</td> <td data-bbox="1045 1465 1421 1497">Deviates RF output 75 kHz peak.</td> </tr> <tr> <td data-bbox="711 1497 836 1528">45 KHz</td> <td data-bbox="1045 1497 1421 1528">Deviates RF output 45 kHz peak.</td> </tr> <tr> <td data-bbox="711 1528 836 1560">EXT VIDEO</td> <td data-bbox="1045 1528 1421 1560">Connects J16 to modulator input.</td> </tr> <tr> <td data-bbox="711 1560 836 1591">RESPONSE</td> <td data-bbox="1045 1560 1502 1591">Deviates RF output with 100 Hz sawtooth.</td> </tr> <tr> <td data-bbox="711 1591 836 1644">DERIVATIVE</td> <td data-bbox="1045 1591 1502 1644">Connects outputs of internal limiter-discriminator, J43, and J48 to derivative amplifier.</td> </tr> </tbody> </table> <p>Controls radio frequency oscillator connected to J43, J52, and internal limiter-discriminator.</p> <p>Attenuates RF output at J52 from 0 to 70 dB in 10 dB steps.</p> <p>Modulation input through S9 position EXT VIDEO.</p> <p>Output of internal limiter-discriminator through S9 positions RESPONSE and DERIVATIVE.</p> <p>Output of J43 and J48 through S9 positions RESPONSE and DERIVATIVE.</p> <p>Connection from output of 100 Hz sawtooth generator.</p> <p>Connect test facility to AUT (limiter-discriminator).</p> <p>Modem output, controlled by AT1, S9, and S114.</p>	<i>Sw pos</i>	<i>Function</i>	100 Hz	Meter M1 indicates 100 Hz sawtooth level.	1 KHz	Meter M1 indicates 1 kHz oscillator level.	50 KHz	Meter M1 indicates 50 kHz oscillator level.	30 MHz	Meter M1 indicates 30 MHz signal level.	300 KHz	Deviates RF output 300 kHz peak.	180 KHz	Deviates RF output 180 kHz peak.	75 KHz	Deviates RF output 75 kHz peak.	45 KHz	Deviates RF output 45 kHz peak.	EXT VIDEO	Connects J16 to modulator input.	RESPONSE	Deviates RF output with 100 Hz sawtooth.	DERIVATIVE	Connects outputs of internal limiter-discriminator, J43, and J48 to derivative amplifier.
<i>Sw pos</i>	<i>Function</i>																								
100 Hz	Meter M1 indicates 100 Hz sawtooth level.																								
1 KHz	Meter M1 indicates 1 kHz oscillator level.																								
50 KHz	Meter M1 indicates 50 kHz oscillator level.																								
30 MHz	Meter M1 indicates 30 MHz signal level.																								
300 KHz	Deviates RF output 300 kHz peak.																								
180 KHz	Deviates RF output 180 kHz peak.																								
75 KHz	Deviates RF output 75 kHz peak.																								
45 KHz	Deviates RF output 45 kHz peak.																								
EXT VIDEO	Connects J16 to modulator input.																								
RESPONSE	Deviates RF output with 100 Hz sawtooth.																								
DERIVATIVE	Connects outputs of internal limiter-discriminator, J43, and J48 to derivative amplifier.																								

3-22. POWER SUPPLY Section Control, Indicator, and Connectors

Controls/indicators	Function
Switch S2 (-position rotary switch).....	Move from OFF position to switch off --12 and +12 volt ac internal supplies. Connects meter M1 to voltages from AUT trough S5 position S2. Set to OFF to remove power from AUT. <i>Sw pos</i> <i>Meter indication</i>
24V	Level of 24 volt dc supply from regulator of power supply under rest.
+ 12 V	Level + 12 volt dc supply from regulator of power supply under test.
Meter +12 V	+ 12 volt dc metering voltage from regulator of power supply under test.
METER -12 V	-12 volt dc metering voltage from regulator of power supply under test
26 V UNREG	Level of + 26 volt dc supply from chassis under test.
24 V UNREG.....	Level of 24 volt dc supply from chassis under test.
Indicator.....	Lights when S2 is moved from OFF.
Switch S3 DC LOAD.....	Press and hold to load J3.
Connector J1 RIPPLE.....	Connection to ripple voltages through S2 positions METER +12V, METER -12 V, 26 V UNREG, and 24 V UNREG.
Connectors J2 and J4.....	Connect receiver test facility AUT (chassis).
Connector J3.....	Connects receiver test facility to AUT (power supply).
Connector J4.....	Connects receiver test facility to AUT (regulator).

3-23. RF AMPLIFIER-MIXER CONVERTER ASSY Section Control, and Connectors

Controls/indicators	Function
Switch S4.....	Set to ON, connect power to internal IF, and RF amplifiers and AUT. Connects metering voltage from AUT W metering section.
GAIN control.....	Adjusts gain of internal IF. amplifier.
Connector J5 IN.....	Input connection to internal IF. amplifier.
Connector J7 OUT.....	Output connection from internal IF. amplifier.
Connector J6 RF IN.....	Input connection to internal RF amplifier.
Connector J8 RF OUT.....	Output connection from internal RF amplifier.
Connector J9.....	Connects receiver test facility to AUT.

3-24. TUNER RADIO FREQ Controls, Indicators and Connectors

Controls/indicators	Function
Switch S6 (9-position rotary switch).....	Connects power to AUT, and internal diode semiconductor assembly, synthesizer doubler, IF. amplifier, discriminator, and video amplifier. Connects metering voltages to meter M1 through S5 position S6. <i>Sw pos</i> <i>Meter indication</i>
REFL PWR	Reflected RF power level at output of AUT.
XMTR PWR	RF power level at output of AUT.
OSC.....	Output level of internal synthesizer.
DBLR	Output level of internal frequency multiplier.
MULTIPLIER.....	Output level of frequency multiplier in AUT.
REC SIG	Received, signal level from internal video amplifier.
24 CHAN	24-channel pcm level from internal video amplifier.
FDM	Fdm level from internal video amplifier.
OF	Disconnects all circuits from metering section.
SYNC alarm.....	Lights when internal synthesizer has fault condition.
HIGH SIGNAL alarm.....	Lights when receive protection circuit in AUT operates.
GAIN control.....	Adjusts gain of internal IF. amplifier and IF. amplifier in AUT when S7 is set to MAN.
Switch S7.....	Set to MAN, open a loop and connects GAIN control to agc line. Set to AGC, disconnects GAIN control and closes agc loop.
Connector J10 DOUBLER INPUT.....	Input connection to internal doubler.

3-24. TUNER RADIO FREQ Section Controls, Indicators, and Connectors-Continued

Controls/indicators	Function
Connector J11 DISCRIMINATOR INPUT.	Input connection to internal limiter-discriminator.
Connector J12.....	Connects receiver test city to AUT, and RF modules test facility.
Connector J13 VIDEO OUT.....	Output connection from internal video amplifier.
Connector J14 SYNTHESIZER OUTPUT.....	Output connection from internal synthesizer.
Connector J15 IF OUTPUT.....	Output connection from internal IF. amplifier.

3-25. SYNTHESIZER FREQUENCY MHz Section Control, and Indicator

Controls/indicators	Function
Indicator.....	Lights when internal synthesizer, or synthesizer in AUT, is programmed
Switch S8.....	Programs internal synthesizer and synthesizer in AUT for the output frequencies selected.

3-26. RADIO RCVR Section Controls and Connectors

Controls/indicators	Function
Switch 10 (4-position rotary switch).....	Connects ac power to AUT, and meter M1 to AUT power supply through switch S5 position S10. <i>Sw pos</i> <i>Meter indication</i>
	-12 V Voltage of AUT - 12 volt dc supply.
	+12 V Voltage of AUT + 12 volt dc supply.
	+26 V Voltage of AUT + 26 volt dc supply.
	OFF Disconnects ac power.
Switch S11, HIGH SIG ALM.....	Pressed and held to test high-signal alarm indicator on AUT.
Connector J17 VIDEO.....	Connection from video output of AUT.
Connector J18 PCM.....	Connection from pcm output to AUT.
Connector J19 IF IN.....	Connection to IF. input of AUT.
Connectors J20 and J25.....	Connect receiver test facility to AUT.
Connector J21 FDM.....	Connection from fdm output of AUT.
Connector J22 OW.....	Connection from order wire output of AUT.
Connector J23 TIMING.....	Connection from timing output of AUT.
Connector J24 RF OUT.....	Connection from RF output of AUT.

3-27. AMPLIFIER IF AMPL FREQ MULT Section Controls, and Connectors

Controls/indicators	Function
Switch S12 (3-position rotary switch).....	Connects power to AUT at J28 and J35. <i>Sw pos</i> <i>Function</i>
	AMPL IF..... Connects power to AUT at J28 and at J35.
	AMPL FREQ MULT Connects power to AUT at J36.
	OFF Disconnects power from AUT.
GAIN control.....	Adjusts gain of AUT at J28 and at J35.
Switch S13.....	Set to MAN, connects GAIN control to J28 and J35. Set to AGC, connects agc voltage from AUT at J28 to J28 and J35.
Connector J27 IF.....	IF. output connection from AUT at J28.
Connector J28 PRE IF.....	IF. output connection from AUT at J35.
Connector J28.....	Connects receiver test facility to AUT.
Connector J35.....	Connects receiver test facility to AUT.
Connector J29 RF IN.....	Connection to RF input of AUT at J36.
Connector J32 RF OUT.....	Connection from RF output of AUT at J36.
Connectors J30(+) and J31(-).....	RF metering voltage connections from AUT at J36.
Connector J36.....	Connects receiver test facility to AUT.

3-28. RESTORER PULSE FORM Section Controls, and Connectors

Control, indicator, fuse, or connector	Function
Switch S15 (6-position rotary switch)	Connects power to AUT and metering voltage from AUT to meter M1 through S5 position S15.
Sw pos	Function
PCM & TMG.....	Connects pcm signal to AUT through PCM
LEVEL control.....	Terminates pcm output of
.....	AUT and connects pcm metering
.....	voltage from AUT to meter M 1.
.....	NOISE Connects noise signal to
.....	AUT through PCM LEVEL control
.....	Terminates pcm output of AUT and
.....	connects to J40. Connects pcm
.....	metering voltage from AUT to meter
.....	M1. Connects order wire output of
.....	AUT to J45 through filter with
.....	handset
.....	response.
OUTPUT	Connects 1 kHz sine wave and noise
.....	signal to
.....	AUT through PCM LEVEL control
.....	Terminates pcm output of AUT and
.....	connects to J40. Connects order
.....	wire metering voltage from AUT to
.....	meter M1. Connects order wire
.....	output of AUT to J45 through filter
.....	with handset response.
RESPONSE	Connects J39 to AUT and order wire
.....	output of
.....	AUT to J45.
.....	Connects J39 to AUT and order wire
.....	output of AUT to J45 through 1 kHz
.....	notch filter.
.....	Disconnects power and M 1 from AUT.
FREQ ADJ control	Adjust frequency of pcm oscillator. Checks sync of timing pulses by
.....	varying frequency.
Switch S16 (spring-loaded)	In TEST position, operates order wire relay in AUT. Mutes pcm
.....	output by removing 91-ohm termination.
PCM LEVEL control.....	Adjusts pcm input level to AUT.
Connector J38 PCM LEVEL	Connection to pcm input of AUT.
Connector J39 AF IN.....	Connection to order wire input of AUT. Connection to order wire
.....	input of pcm generator through S15 DISTORTION position.
Connector J40 PCM OUT	Connection from pcm output of AUT.
Connector J41 XMTR	Transmitter modulating signal output amplitude adjusted by PCM
.....	LEVEL.
Connector J42	Connects receiver test facility to AUT.
Connector J44 SYN OUT	676 kHz square wave output.
Connector J45 OW OUT.....	Connection from order wire output of AUT through S15.
Connector J46 TIMING OUT.....	Connection from timing output of AUT.
Connector J47 MODEM	Modem modulating signal output amplitude adjusted by PCM LEVEL.

3-29. ELECTRONIC SWITCH Section Controls, Indicators, and Connectors

Control, indicator, fuse, or connector	Function
Switch S17	Connects power to AUT. Connects ripple voltages to J49. Connects
.....	meter M1, through S19 and S6. position S20, to metering voltages
.....	from internal power supply or power supply under test.
Sw pos	Meter indication
+12V	+12 volt dc supply voltage through S9.
-12 V.....	- 12 volt dc supply voltage through S19.
100 V.....	100 volt dc supply voltage through S19.
.....	200 volt dc supply voltage through S19.
6 V.....	Voltage of receive bias supply through
.....	S19.
Switch 18.....	ALARM TEST..... Voltage of load bias supply through S19.
.....	In ALARM TEST position, provides an alarm drive signal to internal
Connector J49 RIPPLE	power supply and AUT.
Switch S19	Connection to power supply ripple voltages through S19 and S17.
.....	Set to INT, connects internal power supply to J50. Set to EXT,
Connectors J50 and J51	connects power supply under test at J61 to internal loads.
.....	Connect receiver test facility to AUT.

3-30. AMPLIFIER VIDEO Section Controls, Indicators, and Connectors

Controls/indicators	Function										
Switch S20 (4-position rotary switch).	Connects power to AUT. Connects meter MI to metering voltages from Aut through SS, position S17.										
	<table border="0"> <tr> <td data-bbox="646 369 730 394"><i>Sw pos</i></td> <td data-bbox="1039 369 1218 394"><i>Meter indication</i></td> </tr> <tr> <td data-bbox="646 394 730 420">RCVR SIG.</td> <td data-bbox="941 394 1299 420">Received signal level from AUT.</td> </tr> <tr> <td data-bbox="698 420 828 445">24 CHAN.....</td> <td data-bbox="1039 420 1396 445">24-channel pcm level from AUT.</td> </tr> <tr> <td data-bbox="698 445 828 470">FDM.....</td> <td data-bbox="1039 445 1266 470">Fdm level from AUT.</td> </tr> <tr> <td data-bbox="698 470 828 495">OFF</td> <td data-bbox="1039 470 1445 495">Disconnects power and MI from AUT.</td> </tr> </table>	<i>Sw pos</i>	<i>Meter indication</i>	RCVR SIG.	Received signal level from AUT.	24 CHAN.....	24-channel pcm level from AUT.	FDM.....	Fdm level from AUT.	OFF	Disconnects power and MI from AUT.
<i>Sw pos</i>	<i>Meter indication</i>										
RCVR SIG.	Received signal level from AUT.										
24 CHAN.....	24-channel pcm level from AUT.										
FDM.....	Fdm level from AUT.										
OFF	Disconnects power and MI from AUT.										
Switch S21 COMPENSATING NETWORK	Set to IN, connects frequency compensating network between J53 and AUT at J55.										
PCM OUT indicator	Lights when AUT low signal alarm rely is normal										
LOW SIGNAL indicator.....	Lights when AUT low signal alarm relay operate.										
Connector J53 VIDEO OUT	Connection from video output of AUT.										
Connector J54 PCM OUT.....	Connection from pcm output of AUT.										
Connector J55Connects receiver test facility to AUT.											

**Section III. ACCESSORY KIT, TEST -FACILITIES SET
MK-1173(V)2/GRM-95(V)2 CONTROLS, INDICATORS, FUSES,
AND CONNECTORS**

3-31. General

The operating controls, indicators, fuses, and connectors of the test sets, test stand, and power supply in the accessory kit are listed in paragraphs 3-32 through 3-35.

Throughout this section, the ANIGRC-103(V) assembly under test is referred to as AUT.

3-32. Power Supply PP-63041GRM-95(V)2, Controls, Indicators, Fuses, and Connectors (fig. 3-3)

Controls/indicators	Function
AC connectors facility, AC POWER switch isolation	Connect power supply to transmitter test facility and receiver test Connects ac power to ac connectors through voltage control and transformer.
AC POWER indicator ON.	Lights when ac power is connected to the power supply and SI is set to
AMPERES meter	Indicates total current at ac connectors on 0 to 5 ampere scale.
VOLTS meter	Indicates voltage at ac connectors on 105 to 125 volt scale
Voltage control	Controls voltage supplied to ac connector.
5 A FUSE (2)	Protect power supply from currents greater than 5 amperes
SPARE FUSE	Hold spare 5 ampere fuse

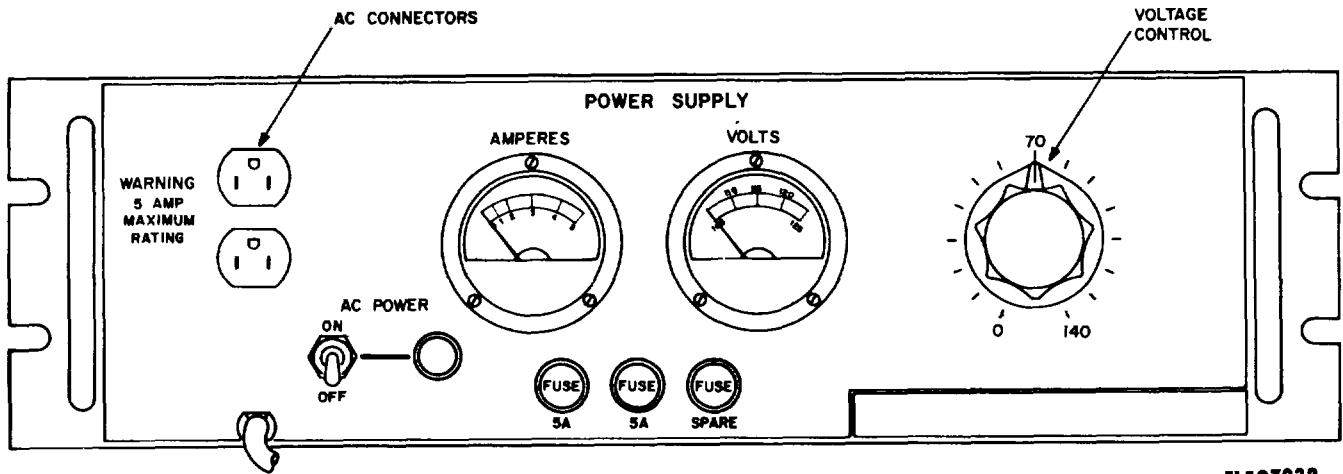

Figure 3-3. Power Supply Front Panel.

3-33. Test Set Control-Indicator, Control, Indicators, and Connectors (fig. 3-4)

Controls/indicators	Function
Tape control thumb wheel	Moves tape which displays control line status for corresponding channel number of AUT type shown in TYPE NO. window.
Connector J1	Connects test set to control indicators 2A2 and 6A3 (AUT).
Connector J2	Connects test set to control indicators 33A4, 34A4, 37A2, 38A2, 39A4, and 40A4 (AUT).
Control line indicators TYPE NO. indicator is	Indicate status of AUT control line. Indicates which type of control-indicator the test set is adjusted to test; 6A3
CHANNEL indicator	type No. 406-26512; 2A2 is type No. 406-265/8. Indicates channel to which test set is set.

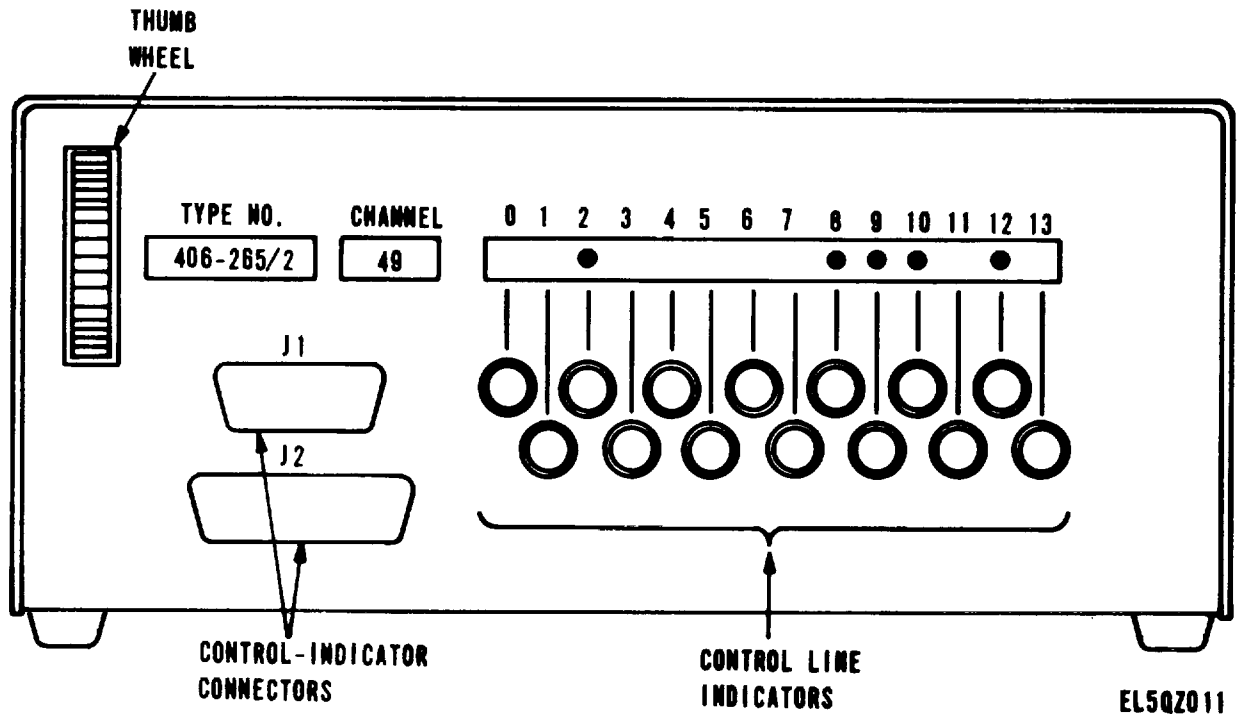

Figure 3-4. Test set, Control-Indicator TS-3031/GRM-95(V)2, Controls, Indicators, and Connectors.

3-34. Test Stand, Frequency Multiplier 407-22411, Controls, Indicator, and Connector (fig. 3-5)

Controls/indicators	Function
<p>Electronic switch</p> <p>Connector P2</p> <p>Clamp</p> <p>Counter input adapter</p> <p>Counter</p> <p>Control knob</p> <p>J1, J2, J3, and J4</p> <p>J5.</p> <p>J6</p>	<p>Used in conjunction with test equipment and electronic switch section of transmitter test facility to route RF signals through times-2 or times-3 multipliers in AUT.</p> <p>Connects electronic switch to J34 or transmitter test facility.</p> <p>Secures AUT in test counter.</p> <p>Connects AUT to counter.</p> <p>Counts from 1/10 to 9999-99/10 revolutions in 1/10 steps.</p> <p>Sets counter indication and tunes AUT.</p> <p>Connect electronic switch to AUT.</p> <p>Input connection of electronic switch.</p> <p>Output connection of electronic switch.</p>

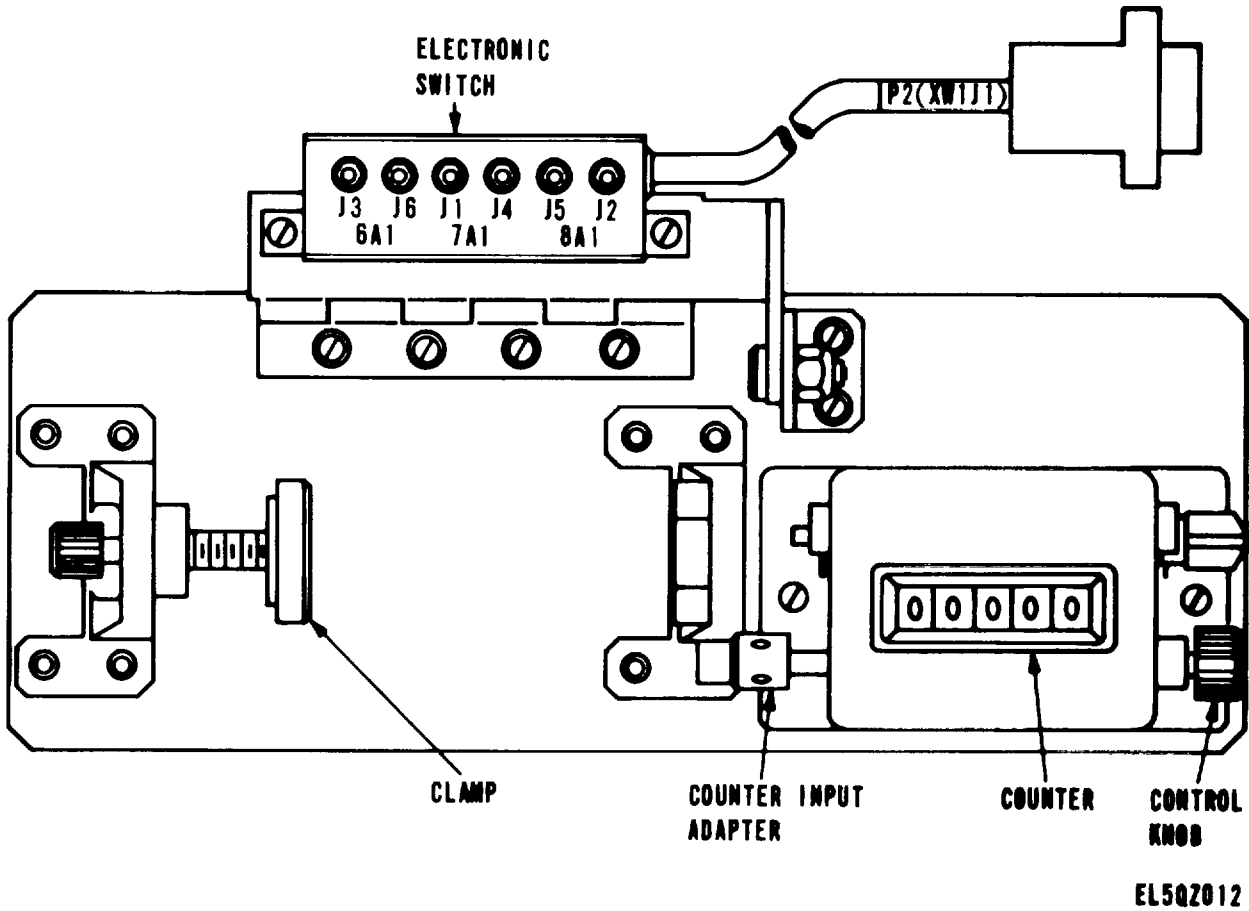

Figure 3-5. Test Stand, Frequency Multiplier 407-224/1, Controls, Indicators, and Connectors.

**3-35. Test Set, Interconnecting Box TS-2870/GRM-95(V)2, Controls, Indicator, and Connectors
(fig. 3-6)**

Controls/indicators	Function
RECEIVER connectors J1, J3, J5 TRANSMITTER connectors J2, J4, J6 FAULT indicator lamp Switches S1 and S2	Connect test set to receiver case under test. Connect test set to transmitter case under test. Indicates status of circuit under test through S1 and S2. Used together to test either transmitting or receiver case wiring.

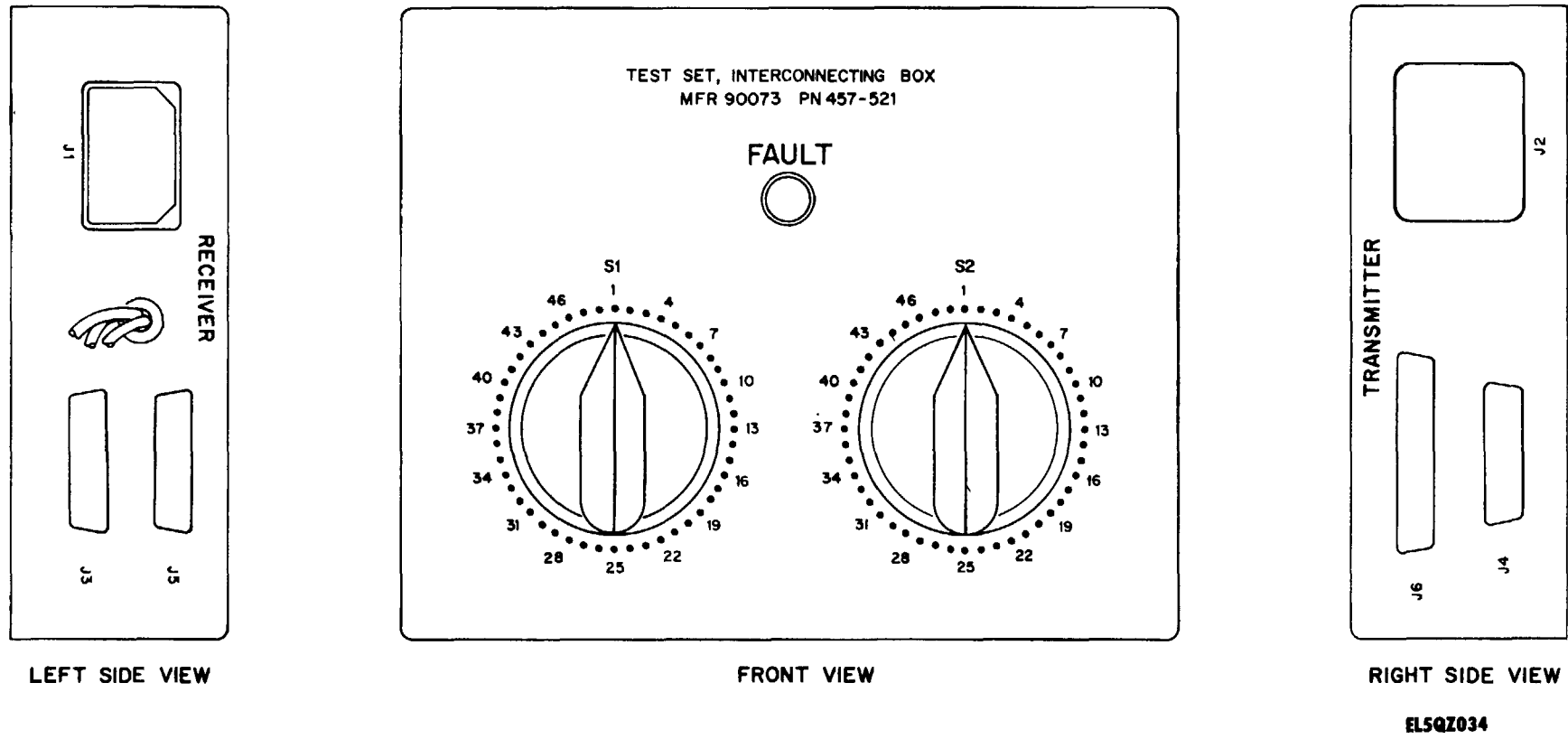

Figure 3-6. Test Set, Interconnecting Box TS-2870/GRM-95(V)2, Controls, Indicator, and Connectors.

Section IV. OPERATION UNDER USUAL CONDITIONS

3-36. Operational Procedures

For any type of operation, perform the following procedures:

- a. Preliminary starting procedure (para 3-37).
- b. Starting procedure (para 3-38).
- c. Appropriate maintenance procedure as described in TM 11-5820-540-40-1, -2, and -3. Stopping procedure (para 3-39).

3-37. Preliminary Starting Procedure

a. Set the power supply AC POWER switch to OFF and turn the voltage control fully counterclockwise.

b. Set transmitter test facility switches S1 and S6 to OFF, S2 and S13 to their off (down) positions, S15 to DRIVER, S16 to OUTPUT NORMAL, S27 to indicator A (right-hand position), and S29 to OUTPUT. Set S12, S17, S18, S21, S25, S26, S28, S30, S31, and S32 to OFF. Set S4 and S20 to + 12 V. Be sure that the power supply section hinged cover is closed.

c. Set receiver test facility switches S1 to OFF, S7 to MAN., S13 to MAN., S18 to NORM., and S21 to OUT. Set S5 to -12 V. S14 to 30 MHz, S19 to EXT, and AT1 to 0 DB. Set S2, S4, S6, S8, S10, S12, S15, S17, and S20 OFF.

d. Set radio frequency modules test facility switches S1, S4, S7, S8, S11, S12, S13, S14, and S15 to OFF. Set switch S9 to its off position (down).

3-38. Starting Procedure

a. Connect the transmitter test facility alternating current (ac) power cable to an ac connector on the power supply.

b. Connect the receiver test facility ac power cable to the other ac connector on the power supply.

c. Connect the power supply ac power cable to a 115 volt ac power source.

d. Set the power supply AC POWER switch to ON; the AC POWER indicator should light.

e. Turn the power supply voltage control until the VOLTS meter indicates 115 volts.

NOTE

During Radio Set AN/GRC-103(V)1, 2, 3, or 4 testing procedures, the VOLTS meter indication may vary as the load varies. Periodically check the VOLTS meter and adjust the voltage control for 115-volt indication if necessary.

f. Connect the RF modules test facility to the transmitter or receiver test facility as required, and proceed as described in a, or b, and c above for the appropriate test facility being used.

NOTE

The radio frequency modules test facility is connected to either the receiver or transmitter test facilities as directed by the procedures in TM 11-5820-540-40-1, -2, and -3.

3-39. Stopping Procedure

a. Set the power supply AC POWER switch to OFF.

b. Disconnect the transmitter test facility ac power cable from the power supply.

c. Disconnect the receiver test facility ac power cable from the power supply.

d. Disconnect the power supply ac power cable from 115-volt ac power source.

e. Disconnect the RF modules test facility interconnecting cable from the DISTRIBUTION section to either the transmitter or receiver test facilities.

Section V. TEST FACILITY, RADIO FREQUENCY MODULES

TS-3837(V)2/GRM-95(V)2, CONTROLS INDICATORS, AND

CONNECTORS

3-40. General (fig. 3-7)

The test facility, radio frequency modules controls, indicators, fuses, and connectors are listed, with their

functions, in paragraphs 3-41 through 3-50. Throughout this section, the AN/GRC-103(V)1, 2, 3, and 4 assembly under test is referred to as AUT.

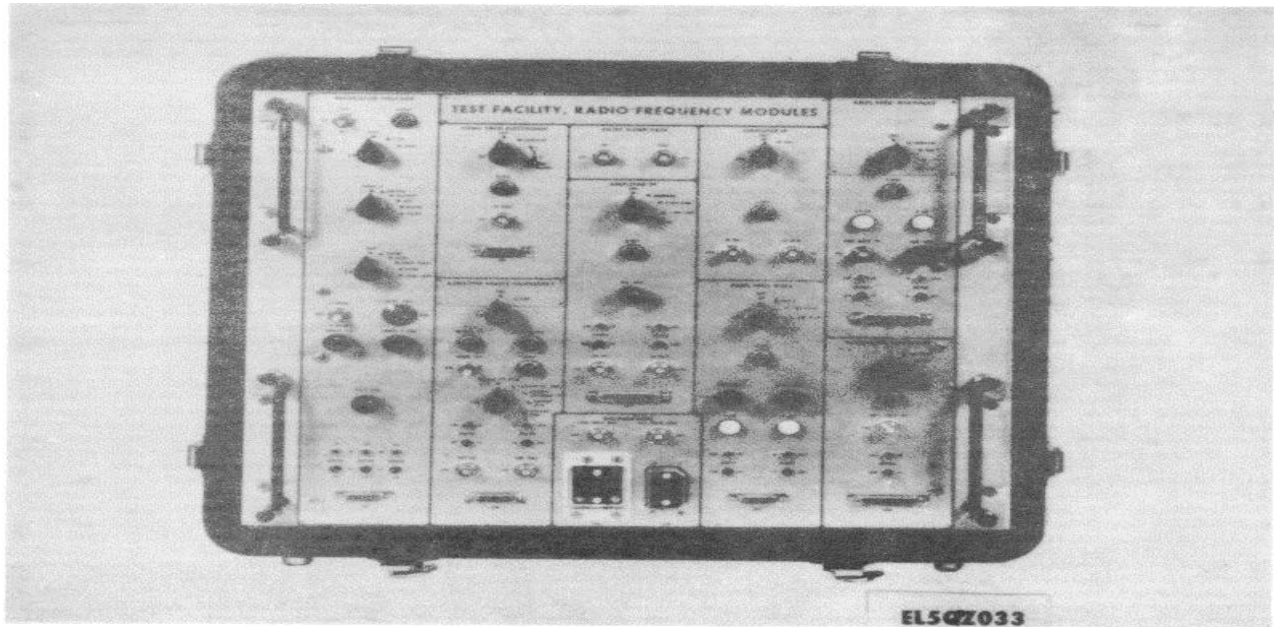

Figure 3-7. Test Facility, Radio Frequency Modules, Front Panel.

3-41. REGULATOR VOLTAGE Section Controls, Indicators, and Connectors

Controls/indicators	Function
Switch S1 to in- SUPPLY indicator Switch S2 8.0 Switch S3 circuitry. Switch S4 Switch S5 supply to an Switch S6 100 mA SET control INPUT V ADJ control MAX CUR control Connectors J 1 and J2 SUPPLY Connectors J3 and J4 METER Connectors J5 and J6 METER Connector J7	Connects + 13 volts dc supply (when applied to connectors J1 and J2) to internal voltage regulator circuit. Lights when power is applied to AUT. Selects desired regulated output voltage. 6.4 volts dc, 7.2 volts dc or 8.0 volts dc. Connects test conditions and metering facilities to selected AUT Provides various loads to an AUT. Simulates output impedance of AN/IGRC- 103(V) transmitter power AUT, during short-circuit testing. Applies a dummy load to voltage regulator when setting output voltage. Adjusts current from +28 volts supply to 100 mA. Adjusts 6.4 volt reference output from voltage regulator. Checks the voltage feedback of an AUT. Connect + 13 volt dc supply input. Current monitor points for AUT. Voltage monitor points for DRIVER or OUTPUT circuits from AUT. Connects AUT to test panel.

3-42. CONV FREQ ELECTRONIC Section Controls, Indicators, and Connectors

Controls/indicators	Function
Switch S7 metering ± 12 V indicator Connector J8 IF OUT Connector J9	Provides interconnection for +12 and -12 volts dc supplies and signals. Indicates power applied to AUT. Provides access to IF. signal from AUT. Connects AUT to test panel.

3-43. AMPLIFIER RADIO FREQUENCY Section Controls, Indicators, and Connectors

Controls/indicators	Function
Switch S8 Switch S9 energized and air Switch S10 DRIVER FIL indicator OUTPUT FIL indicator 600 V indicator Connectors J 10 and J 11 METER Connectors J 12 and J13 METER Connector J14 DET IN Connector J15 ALC OUT Connector J16	Connects power from transmitter test facility to the section. Enables 600 V to be supplied to AUT when relay K1 is switch on test fixture has operated and AUT 600 V interlock circuit is completed. Connects an external voltmeter and ammeter into circuitry. Sw pos..... Function DRIVER FIL CUR..... Voltmeter at J12 and J 13 indicates driver filament current multiplied by factor of 0.1. OUTPUT FIL CUR Voltmeter at J12 and J13 indicates output filament current multiplied by factor of 0.1. OUTPUT CATHODE V Voltmeter at J 12 and J 13 indicates the cathode voltage of AUT output tube. DRIVER CUR AUT driver tube cathode current routed through ammeter at J10 and J 11. OUTPUT CUR AUT output tube cathode current routed through ammeter at J10 and J11. Indicates presence of driver tube filament voltage. Indicates presence of output tube filament voltage. Indicates 600 V supply applied to AUT. Metering circuit ammeter connections. Metering circuit voltmeter connections. Input for negative RF detector signal to alc amplifier. Alc levelling signal output. Provides interconnections from AUT through test fixture to test panel

3-44. FILTER BANDPASS Section Connectors

Controls/indicators	Function
Connector J17 IN Connector J 18 OUT	Filter input. Filter output.

3-45. AMPLIFIER RF Section Controls, Indicators, and Connectors

Controls/indicators	Function
Switch S 11 ± 12 V indicator ALC ADJ control Connectors J 9 and J20 METER Connectors J21 and J22 METER Connector J23 RF IN Connector J24 RF OUT Connector J25	Applies operating voltage to AUT and provides metering selections. Sw pos..... Function NORMAL Connects + 12 and - 12 volts dc to AUT directly. + 12 V CUR Routes + 12 volts supply through ammeter connected at J19 and J20. -12 V CUR Routes - 12 volts supply through ammeter connected at J19 and J20. ALC Connects alc voltage to a voltmeter connected at J21 and J22. Lights when operating voltages applied to AUT. Provides manual gain control of AUT. Metering circuit to monitor AUT supply current consumption. Metering circuit to monitor alc voltage to AUT. RF input to AUT. RF output from AUT. Connects AUT to test panel.

3-46. DISTRIBUTION Section Connectors

Controls	Function
Connector J26 XMT DBLR OUT facility.	Provides access to the doubler output signal from transmitter test
Connector J27 RCV DBLR OUT facility.	Provides access to the doubler output signal from the receiver test
Connector J28 test	Connects supply voltages, metering and RF signals from the transmitter facility to the various sections.
Connector J29 test	Connects supply voltages, metering and RF signals from the receiver facility to the various sections.

3-47. AMPLIFIER IF Section Controls, Indicators, and Connectors

Controls/indicators	Function
Switch S12 - 12 V indicator	Connects -12 volts supply to amplifier. Lights when - 12 volts supply is connected to amplifier.
Connector J30 IF IN	Connects to the IF. output from an AUT for amplification.
Connector J31 IF OUT	Provides the amplified output of the section.

3-48. AMPL FREQ MULT Section Controls, Indicators, and Connectors

Controls/indicators	Function
Switch S13 attenuation	Connects supply voltages to AUT. Selects multiplication factors, control lines and alc circuits for AUT.
ALC 1 ADJ control	Adjusts gain of amplifier-frequency multiplier 407-070 in transmitter test facility.
ALC 2 ADJ control	Adjusts gain of AUT.
+ 28 V indicator	Lights when dc power applied to AUT.
12 dB indicator	Lights when relay K1 in AUT energized.
6 dB indicator	Lights when relay K in AUT deenergized.
Connector J32 and J33 METER	Metering circuit to monitor current of + 28 volt supply to AUT.
Connector J34 and J35 METER	Metering circuit to monitor alc voltage.
Connector J36	Connects AUT to test panel.

3-49. AMPL FREQ MULTIPLIER Section Controls, Indicators, and Connectors

Controls/indicators	Function
Switch S14 alc	Connects supply voltages to AUT. Selects attenuation control lines and control for AUT.
ALC1 ADJ control	Adjust gain of amplifier-frequency multiplier 407-070 in transmitter test facility
ALC2 ADJ control	Adjusts output level of AUT.
+ 28 V indicator	Lights when dc power applied to AUT.
6 dB indicator	Lights when relay K1 in AUT energized.
3.5 dB indicator	Lights when relay K in AUT deenergized.
Connector J37 XMT MULT IN	Connects RF input to AUT.
Connector J38 and J39 METER	Metering circuit to monitor alc current.
Connector J40 and J41 METER	Metering circuit to monitor alc voltage.
Connector J42	Connects AUT to test panel.

3-50. FREQUENCY MULTIPLIER Section Controls, Indicators, and Connectors

Controls/indicators	Function
Switch S15 + 12 V indicator	Connects supply voltage to AUT and connects alc circuit to meter jacks. Lights when supply voltage is applied to AUT.
Connector J43 RCV MULT IN	Connects RF input to AUT.
Connector J44 and J45 METER	Metering circuit to monitor alc voltage.
Connector J46	Connects AUT to test panel.

Section VI. TEST FIXTURES 6A1 THROUGH 12A1**3-51. General**

Seven test fixtures form part of the Test Facility Set ANIGRM-95(V)2. Each test fixture is contained in a separate case which is for protection only. Each fixture is a mechanical test stand used to test and align the appropriate modules of Radio Sets AN/GRC-103(V)1, 2, 3 and 4.

3-52. Test Fixture, Frequency Multiplier**TS-3824/GRM-95(V)2****(fig. 3-8)**

The AUT is placed in position against the three locating posts and locked in position by the retaining clamp. The two holes in the baseplate are to facilitate attachment of test cables to connectors J 1 and J2 of the AUT. The drive shaft of the AUT is attached to the flexible drive shaft of the mechanical drive assembly by two retaining screws. The initial setting of the drive shafts is achieved by turning the locking knob counterclockwise.

Loosening the locking knob in this manner allows the tuning shaft control knob to rotate the shaft of the AUT independently of the calibrated dial control knob. The tuning shaft control knob is turned to preset the AUT to a position corresponding to a desired frequency. The locking detent is pressed in and the calibrated dial control knob tuned to set the calibrated dial to the same preset frequency. Releasing the locking detent keeps the calibrated dial locked in the preset position. The locking knob is then turned clockwise locking the two control knobs together. With the two control knobs locked together, adjustment of the calibrated dial by the tuning shaft control knob can be achieved by releasing the locking detent. Any subsequent adjustment of the tuning shaft control knob will now give a corresponding adjustment to the AUT through the drive shafts. Adjustments to the AUT can be made from all exposed sides. The side facing the baseplate of the test fixture has no adjustment points.

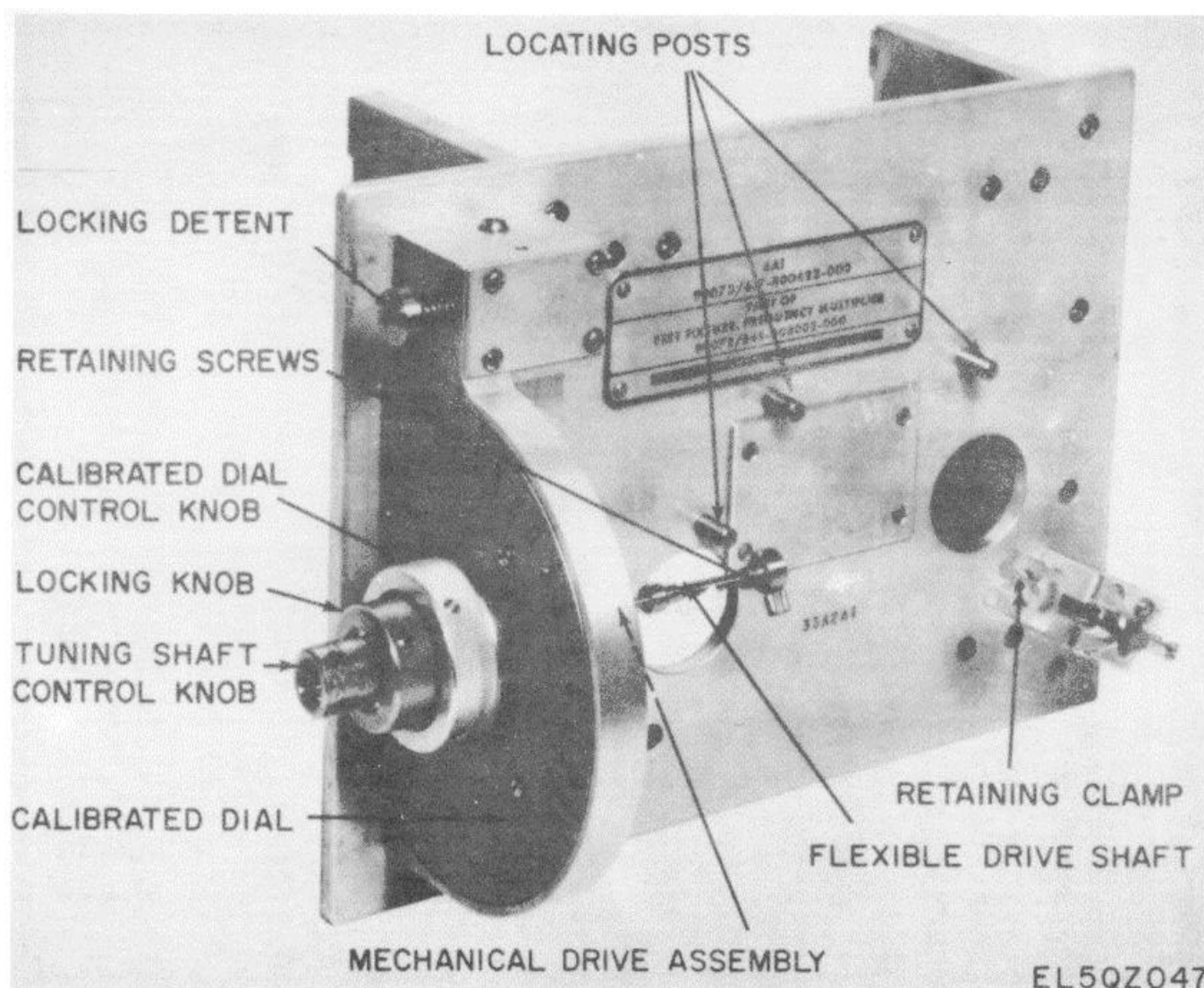

Figure 3-8. Frequency Multiplier Test Fixture TS-3824/GRM-95(V)2.

**3-53. Test Fixture Bandpass Filter
TS-3825(V)IGRM-95(V)2
(fig. 3-9)**

The AUT is placed in position against the retaining plate taking care to engage the two pins on the AUT into the two holes in the retaining plate. The two spacers are used to locate and stabilize the AUT. The AUT is then locked in position by the retaining clamp. The hole in the baseplate is to facilitate attachment of the test cables to the AUT. The shaft of the AUT is connected to the flexible drive shaft of the test fixture by two retaining screws. The initial setting of the drive shafts is achieved by turning the locking knob counterclockwise. Loosening the locking knob in this manner allows the

tuning shaft control knob to rotate the shaft of the AUT independently of the calibrated dial control knob. The tuning shaft control knob is turned to preset the AUT to a position corresponding to a desired frequency. The locking detent is pressed in and the calibrated dial control knob turned to set the calibrated dial to the same preset frequency. Releasing the locking detent keeps the calibrated dial locked in a preset position. The locking knob is then turned clockwise locking the two control knobs together. With the two control knobs locked together, adjustment of the calibrated dial by the tuning shaft control knob can be achieved by releasing the locking detent. Any subsequent adjustment of the tuning shaft control knob will now

give a corresponding adjustment of the AUT through the drive shafts. Adjustment to the unit under test can now

be made from all exposed sides. The side facing the baseplate has no adjustments.

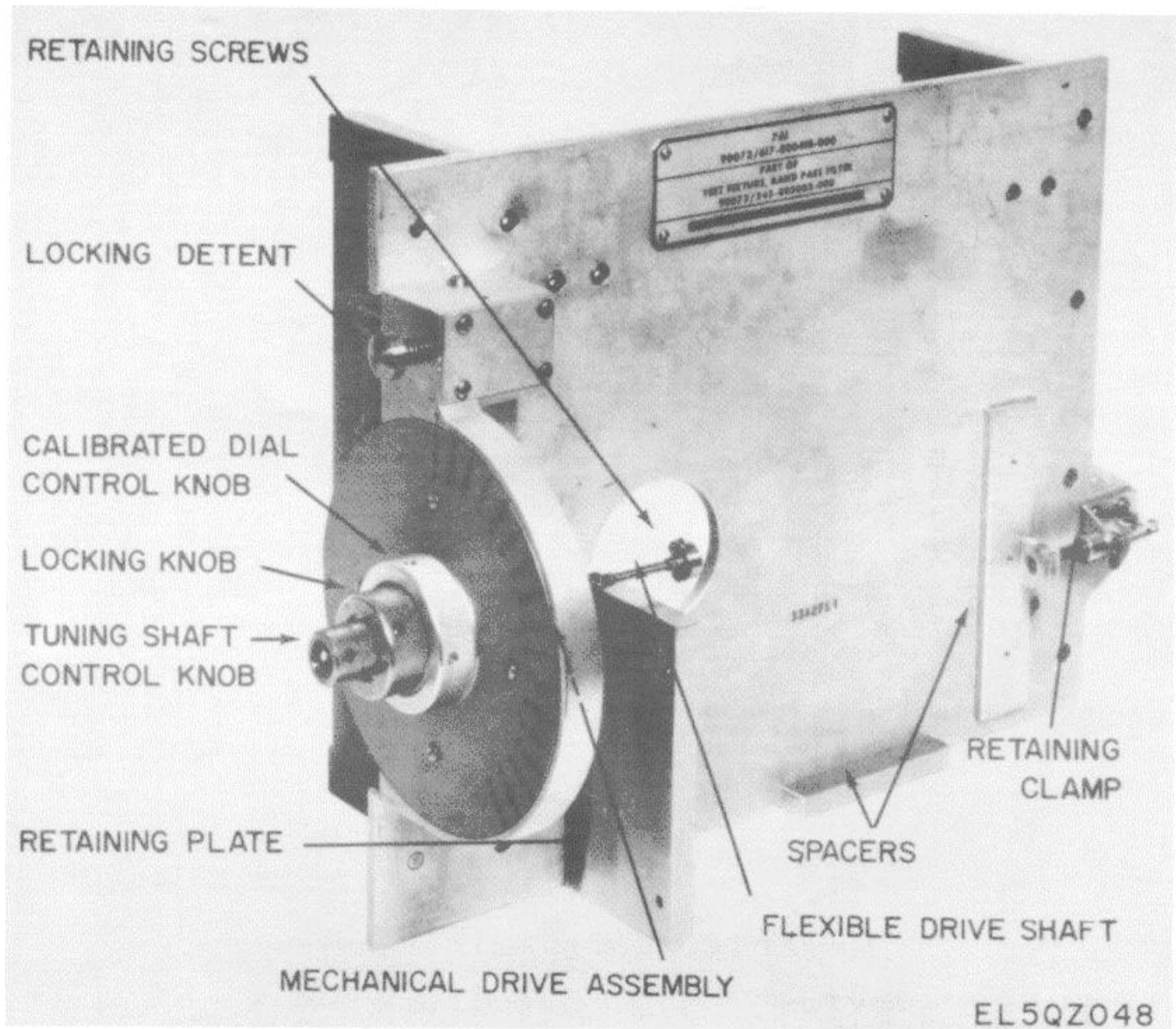

Figure 3-9. Bandpass Filter Test Fixture TS-3825(V)/GRM-95(V)2.

3-54. Test Fixture, Amplifier Frequency Multiplier TS-3826/GRM-95(V)2 (fig. 3-10)

Units 37A1 and 38A1 are similarly mounted on the test fixture so that the respective connectors engage J1 of the test fixture. The tuning shaft of each unit is coupled to a different drive shaft. Both shafts are driven by a common tuning control knob. Unit 38A1 has a plastic drive wheel with teeth which engage two pins on the

drive disk at the end of the flexible shaft. Unit 37A1 has a flexible drive shaft with a coupling which engages the fixed drive shaft of the test fixture. With the unit under test in position, the connector on the AUT mates with the connector J1 on the Last fixture. Connector J1 is parallel wired to J2 which provides the interface for dc supplies and control signal, from the test facility, to the unit under test. The, tuning control knob drives both the

flexible drive shaft and the fixed drive shaft simultaneously by a drive chain. A four digit counter is also activated by the tuning control knob by a clutch assembly on the fixed drive shaft. The counter records the number of revolutions of the control shafts. The counter can be adjusted independently of the tuning control knob by means of the counter control knob which is geared to a slipping clutch. Setting the counter is accomplished by holding the tuning control knob firmly and turning the counter control knob until the desired

setting is registered on the counter. The positions of the drive shafts are not disturbed during this operation. The counter is bidirectional in that it can be operated on either side of zero. Amplifier frequency multiplier 38A1 is driven in a positive direction and the counter reading is positive. Amplifier frequency multiplier 37A1 is driven in the reverse direction and the counter reading is negative. A hole is provided in the baseplate of the test fixture so that the variable capacitor in unit 37A1 can be observed during testing.

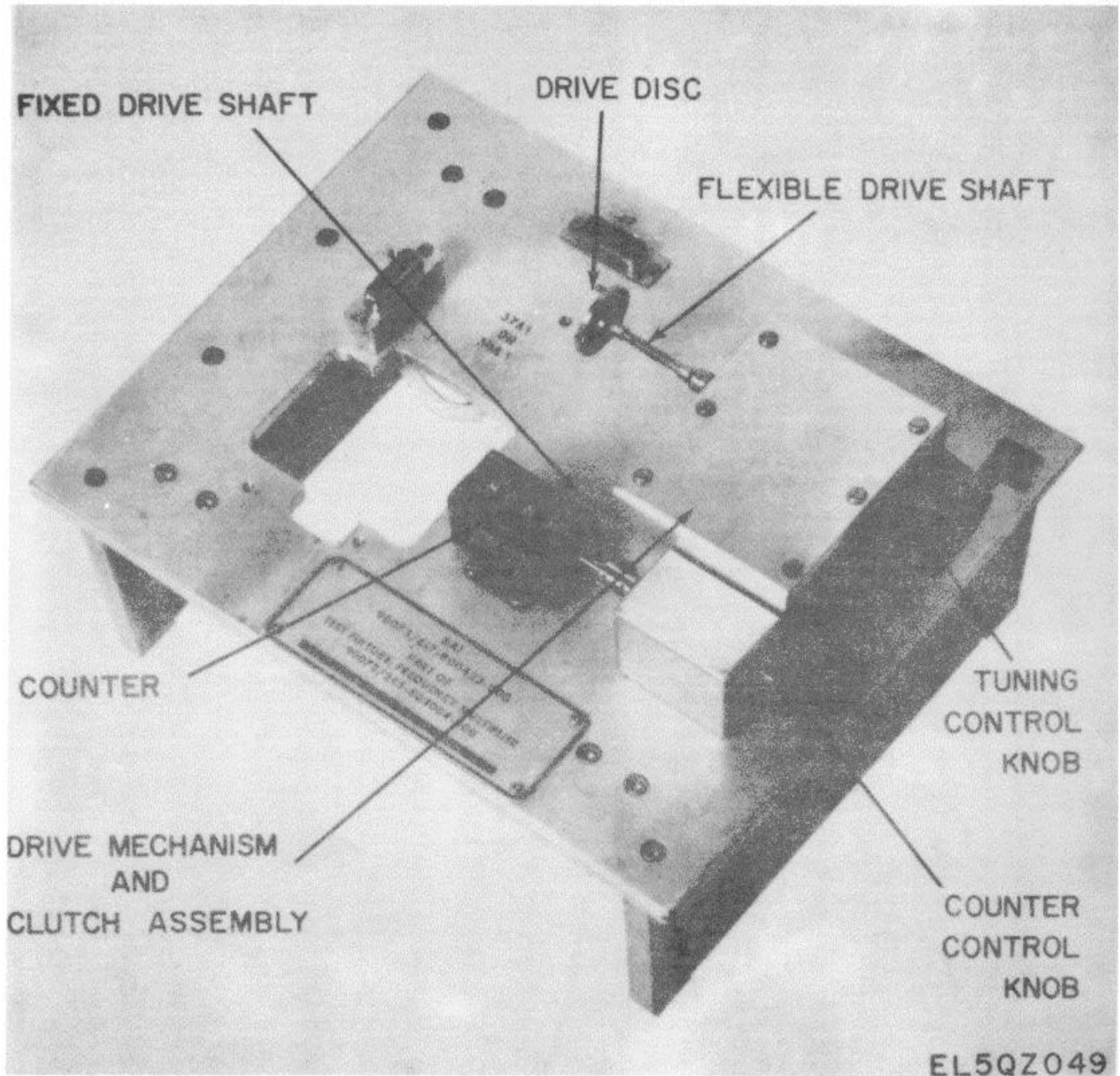

Figure 3-10. Amplifier Frequency Multiplier Test Fixture TS-3826-/GRM-95(V)2.

**3-56. Test Fixture, Bandpass Filter
TS-3827/GRM-95(V)2
(fig. 3-11)**

In order to place an AUT in position on the test fixture, the gage arm must be swiveled from its normal operating position. The gage arm is secured in position by a retaining clamp which in turn is held in position by a thumb screw. Once the thumb screw is loosened, the retaining clamp is repositioned to free the gage arm which can then be moved. The assembly to be tested is then positioned on the test fixture so that the tuning shaft of the assembly is coupled to the flexible shaft of the test fixture. Locating pins on the AUT are also coupled to holes in the test fixture. The mounted assembly is held in position by the two securing screws,

and the gage arm is lowered onto the AUT engaging the tuning plunger of the assembly with one of three calibrated positions in the gage. Each position in the gage arm corresponds to a frequency. The frequencies, which are 1030 MHz, 880 MHz and 725 MHz, are stenciled on the gage arm above their respective position. The input and output cables of the AUT are connected to the right-angle connectors which are provided to facilitate the connection of test cables to the AUT. After testing at one frequency, the gage arm must be lifted in order to reset the AUT to the next position.

CAUTION

Do not lift or remove the test fixture from the case by lifting the fixture with the gage arm.

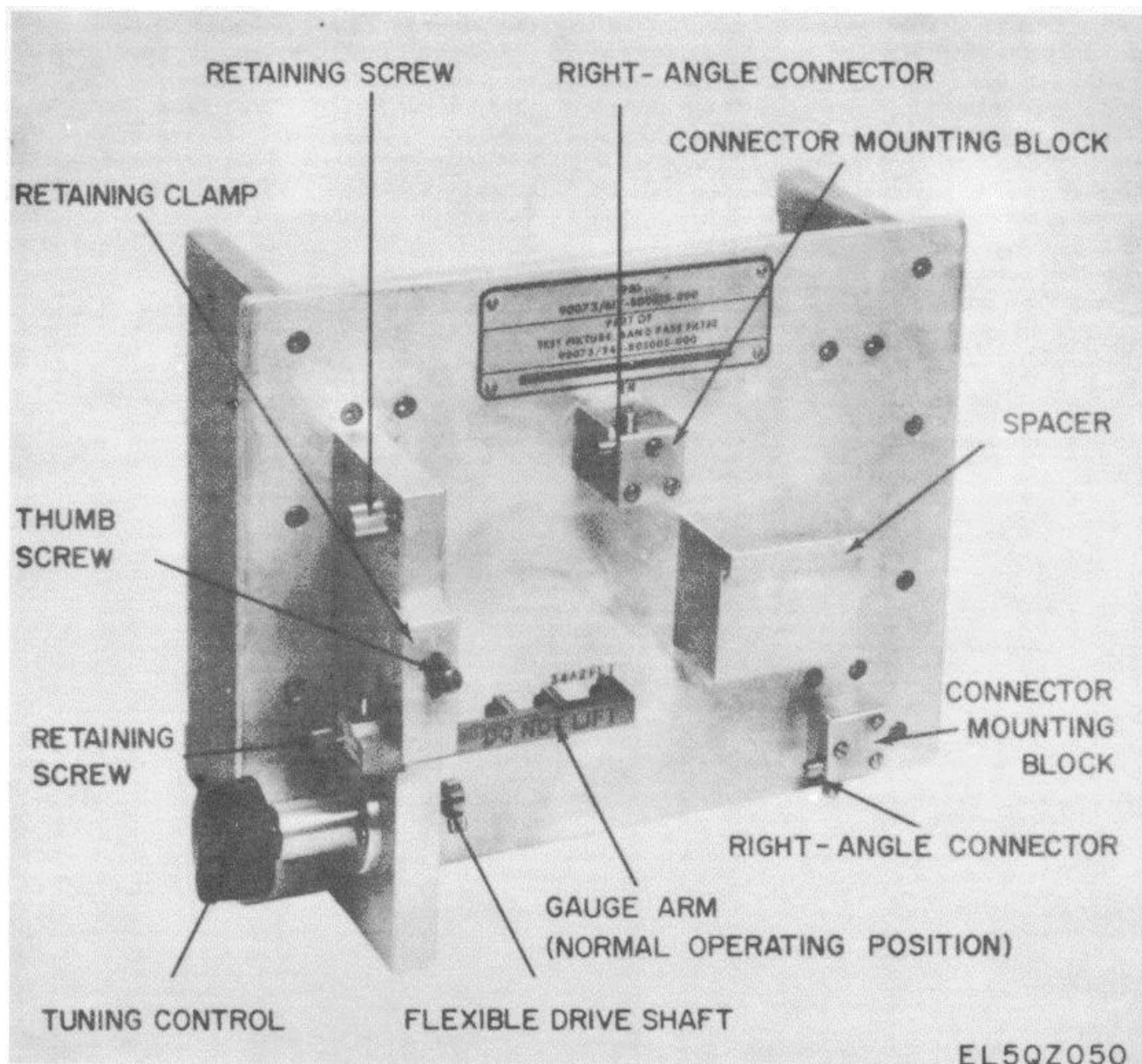

Figure 3-11. Bandpass Filter Test Fixture TS-3827/GRM-95(V)2.

**3-56. Test Fixture, Radio Frequency Amplifier
TS-3828/GRM-95(V)2
(fig. 3-12)**

a. The swiveled mounting block of the test fixture provides support to the rear of an assembly under test, as well as directs air over the output tubes. The swiveled mounting block is secured by a locking screw. The screw is loosened to allow the mounting block to swivel on a pivot to facilitate the mounting on an AUT.

b. The AUT is positioned on the test fixture so that the two locating pins on the unit engage holes in the retaining block adjacent to J3 (fig. 3-12), and the tuning

mechanism meshes with the flexible shaft disk. The flexible shaft disk is connected to the tuning control through a chain driven tuning mechanism. The AUT is secured to the retaining block by a knurled thumb retaining screw. The swiveled mounting block is swiveled into position to secure the rear of the AUT. The swiveled mounting block also contains an air hose clamp. The air hose clamp has a corrugated inside surface which prevents the air hose from being accidentally disconnected. The air hose is a component of

the Accessory Kit, Test MK-1985(V) I/GRM-95(V)2. Air is supplied to the test fixture from the transmitter test facility. When an assembly is mounted on the test fixture and the correct air pressure is being supplied, the contacts of the pressure differential switch will close and complete a 600 volt interlock circuit through connector J1 pins 8 and 9. Closing the interlock circuit permits the 600 volt supply in the transmitter test facility to be switched on and fed to the output tubes of the AUT.

c. Two holes (V1 and V2) are provided in the swiveled mounting block to facilitate adjustment of the

position of the power tubes in the cavities. Three test points J3, J4 and J5, located on the base of the test fixture, are provided to allow resistance measurements of the thermistor mounted on the tubes in the AUT. The direct drive tuning mechanism is controlled by the control knob which also drives the counter. The counter operates in the range from 0.8 to 60.4 MHz and locks at both ends. The counter is calibrated in increments of 0.02 MHz so that the RF amplifier can be checked at any designated point.

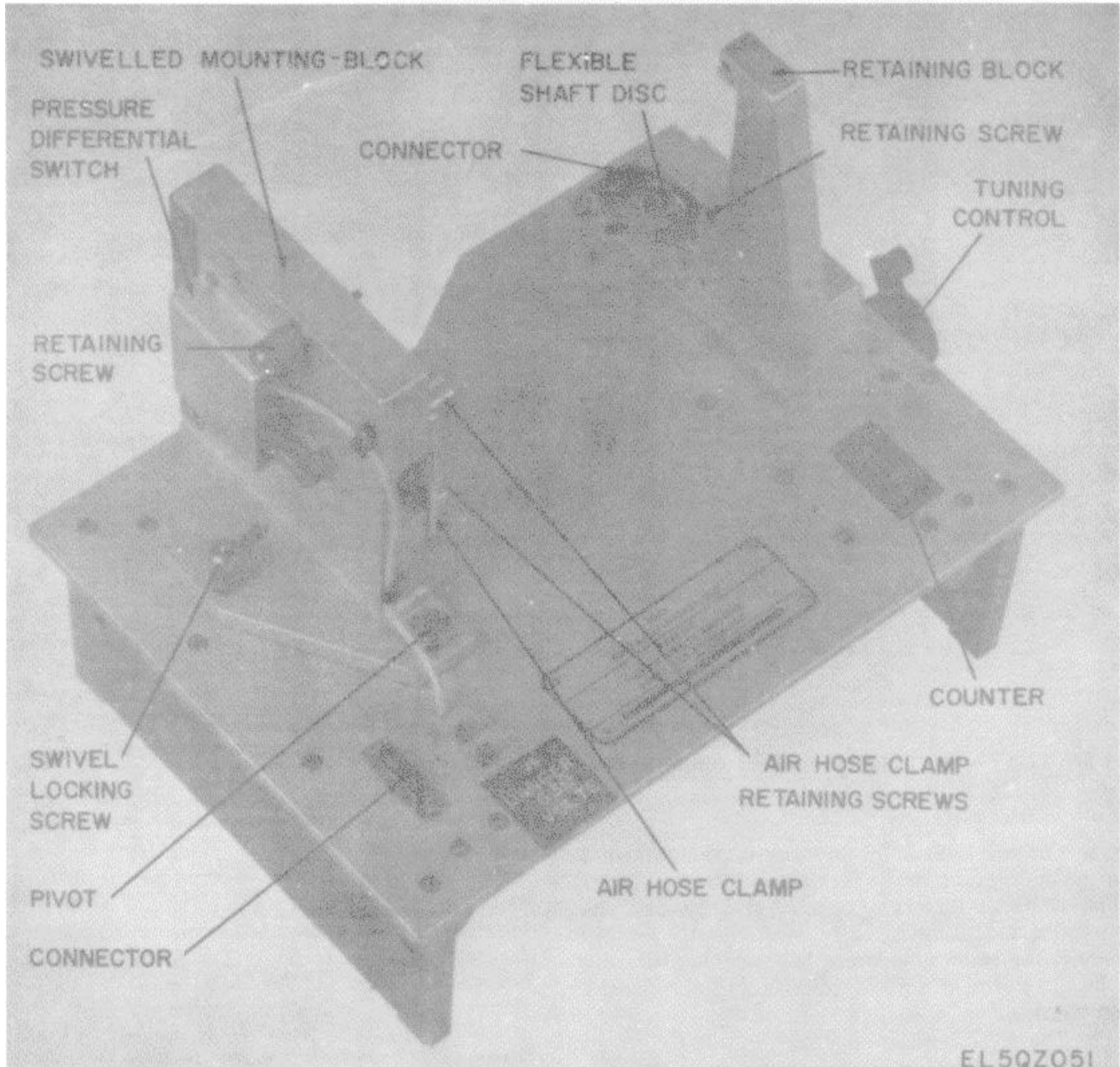

Figure 3-12. Radio Frequency Amplifier Test Fixture TS-3827/GRM-95(V)2.

3-57. Test Fixture, Frequency Multiplier TS-3829/GRM-95(V)2 (fig. 3-13)

The transmitter frequency multiplier 40A2 (245-800491-000) is mounted on the same side of the test fixture as the counter. When the AUT is mounted on the test fixture, the plug of the AUT is automatically engaged with J1 of the test fixture. J1 is parallel wired to J2 through which operating voltages to the AUT are supplied. J2 is connected to the test facility by a special purpose cable 2W5 (457-573). This cable assembly is located in the

transmitter test facility. The tuning mechanism drive locks at the counter setting of 000 and 220 to prevent overdrive. Frequency multiplier 39A3 (245-800487-000) is similarly mounted on the test fixture except that this unit is mounted on the opposite side of the gear assembly to that of the counter. When mounted, the receiver frequency multiplier 39A3 automatically engages J4 which is parallel wired to J3, through which operating voltages are supplied to the 39A3 assembly under test.

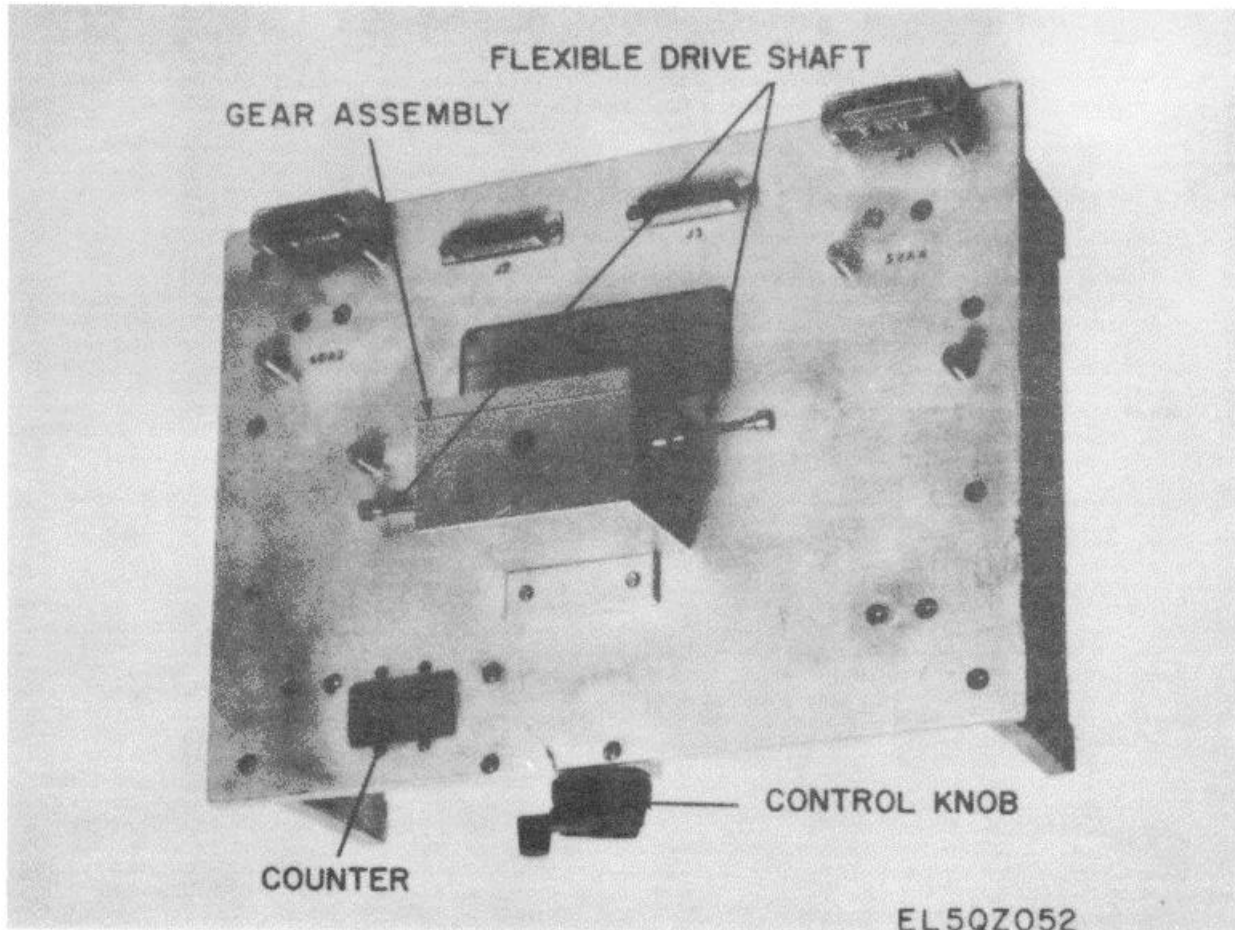

Figure 3-13. Radio Frequency Amplifier Test Fixture TS-3827/GRM-95(V)2.

3-58. Test Fixture, Bandpass filter TS-3830/GRM-95(V)2 (fig. 3-14)

The test fixture is used to test bandpass filters 39FL1, 39FL2, and 40FL1. These filters are mounted vertically and engage the drive shaft and disk on one side of the test fixture. The same test fixture is used to test bandpass filter 39FL3 which is also mounted vertically.

This unit engages the bevel gear on the opposite side of the test fixture. The AUT is held in position by retaining screws located under the baseplate of the test fixture. The tuning mechanism drive locks at the counter settings of 000 and 0985 by locking washers on the main drive shaft. One turn of the control knob produces approximately three turns of the drive shaft.

Filter 40FL1 requires a special mounting post 5MP2 (718-800080-000) located in the Accessory Kit, Test

MK-1985(V)1/ GRM-95(V)2.

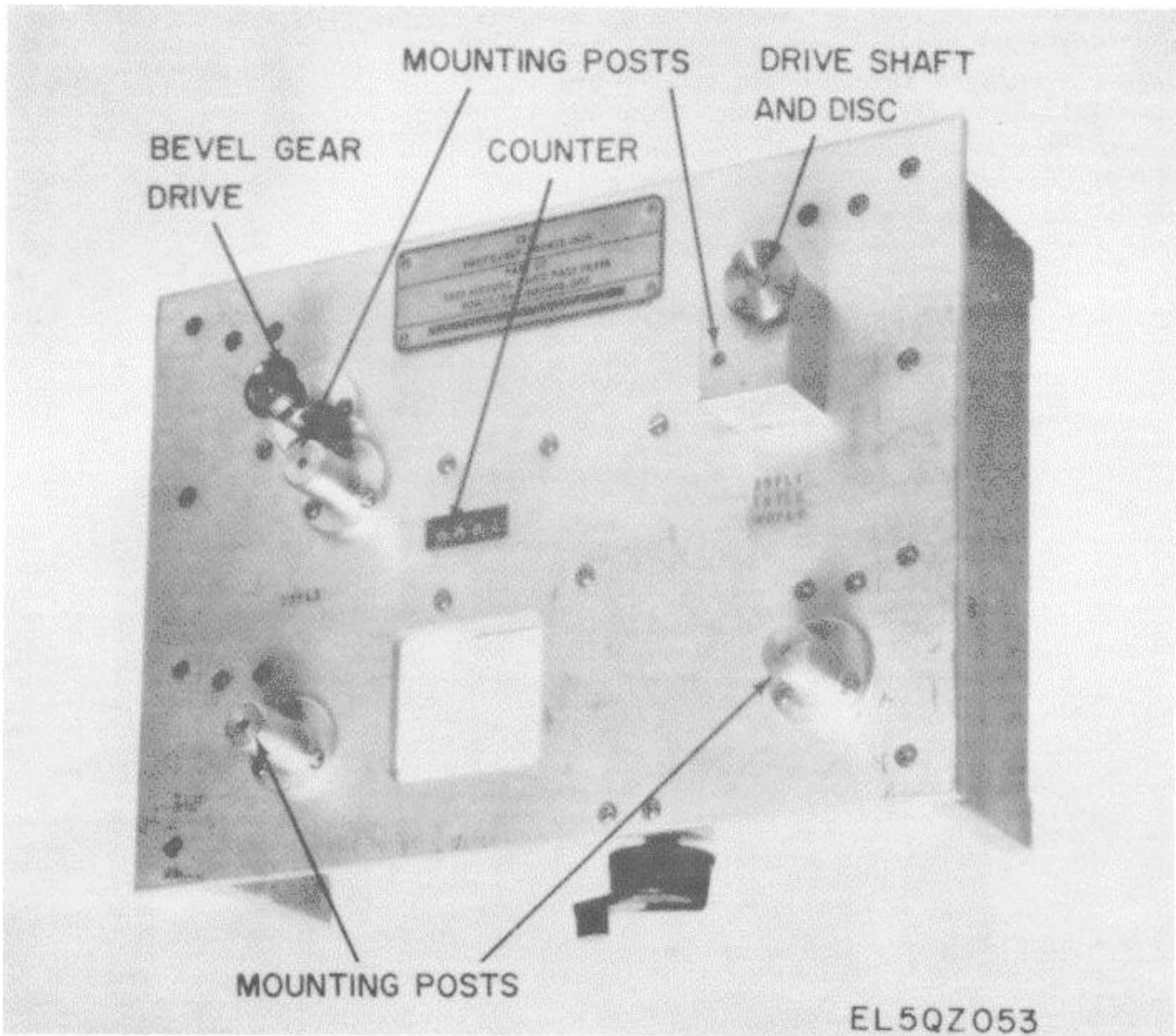

Figure 3-14. Bandpass Filter Test Fixture TS-3&8/GRM-95(V2).

**CHAPTER 4
OPERATOR'S MAINTENANCE
Section I. General**

4-1. Scope of Operator's Maintenance

The maintenance duties assigned to the operator of the test facilities set are listed below, with references to the paragraphs covering these maintenance assignments.

- a. Operator's daily preventive maintenance checks and service charts (para 4-4).
- b. Cleaning (para 4-5).
- c. Replacement of lamps and fuses (para 4-6).

4-2. Operator's Preventive Maintenance

Operator's preventive maintenance is the systematic care, servicing, and inspection of equipment to prevent the occurrence of trouble to reduce downtime, and to assure that the equipment is serviceable.

- a. The procedures given in paragraphs 4-4, 4-5, and 4-6 cover routine systematic care and cleaning essential to proper upkeep and operation of the equipment.

- b. Records and reports of preventive maintenance checks and services must be made in accordance with the requirements set forth in TM 38-750.

4-3. Operator's Preventive Maintenance Checks and Services

Operator's preventive maintenance checks and services of the test facilities set are required daily. Paragraph 4-4 specifies checks and services that must be accomplished daily or under the special conditions listed below.

- a. When the equipment is initially installed.
- b. When the equipment is reinstalled after removal for any reason.
- c. At least once each week if the equipment is maintained in standby condition.

Section II. OPERATOR'S PREVENTIVE MAINTENANCE

4-4. Operator's Daily Preventive Maintenance Checks and Services Chart

Seq No.	Item	Procedure	Reference
1	Completeness	Check to see that equipment is complete and in good condition.	Para 4-5. Chap 3, sec IV.
2	Exterior surfaces	Clean panels and cases	
3	Controls	During normal operation, check to see that each control operates smoothly and is free from external or internal binding.	
4	Meter glasses and indicator lenses	Check meter classes and indicator lenses for cracks	

4-5. Cleaning

Inspect the exterior surfaces of the test facilities set. The exterior should be free of dust, grease, and fungus.

- a. Remove dust and loose dirt with a clean, soft cloth.

WARNING

Adequate ventilation should be provided while using TRICHLOROTRIFLUOROETHANE. Prolonged breathing of vapor should be avoided. The solvent should not ground-in dirt

be used near heat or open flame, the products of decomposition are toxic and irritating. Since TRICHLOROTRIFLUOROETHANE dissolves natural oils, prolonged contact with skin should be avoided. When necessary use gloves which the solvent cannot penetrate. If the solvent is taken internally, consult a physician.

- b. Remove grease, fungus, and

from the cases; use a cloth dampened (not wet) with cleaning compound.

c. Remove dust or dirt from plugs, receptacles; and adapters with a brush.

CAUTION

Do not push on the meter faces (glass) when cleaning; meters may become damaged.

d. Clean the front panels, the meters, and the control knob; use a soft, clean cloth. If dirt is difficult to remove, dampen the cloth with water; use mild soap if necessary.

4-6. Replacements

a. *Replacement of Indicator Lamps.*

(1) Remove the lens that contains the faulty lamp.

(2) Carefully pry the lamp out of the lens.

(3) Insert the replacement lamp in the lens and push the lamp fully into the lens.

(4) Replace the lens on the lamp socket.

b. *Fuse Replacement.*

(1) Remove the fuseholder cap that contains the defective fuse.

(2) Remove the defective fuse from the fuseholder cap.

(3) Insert the replacement fuse in the fuseholder cap.

(4) Replace the fuseholder cap and fuse in the fuse holder.

CHAPTER 5 ORGANIZATIONAL MAINTENANCE

Section I. GENERAL

5-1. Scope of Organizational Maintenance

The organizational maintenance duties for the test facility set are listed below, with reference to the paragraphs covering these maintenance assignments:

- a. Monthly preventive maintenance checks and services (para 5-5).
- b. Quarterly preventive maintenance checks and services (para 5-6).
- c. Cleaning (para 4-5)
- d. Touchup painting instructions (para 5-7).
- e. Organizational troubleshooting chart (para 5-8).
- f. Organizational replacement of assemblies (para 5-9 thru 5-33).

5-2. Tools and Test Equipment Required

The following tools and test equipment are required for organizational maintenance:

- a. *Tools.* Tool Kit, Radio Repairman TK-115/G.
- b. *Test Equipment.*
 - (1) Multimeter AN/URM-105.
 - (2) Insulation Tester AN/GSM-6.
 - (3) Power Supply, Lambda LK342-FM.
 - (4) Power Meter, Hewlett Packard HP-435A.
 - (5) Thermistor Mount, Hewlett Packard HP-8484A.

5-3. Organizational Preventive Maintenance

a. Organizational preventive maintenance is the systematic care, inspection, and servicing of equipment to maintain it in serviceable condition, prevent breakdowns, and assure maximum operational capability. Preventive maintenance is the responsibility of all categories concerned with the equipment and includes the inspection, testing, and repair or replacement of parts, subassemblies, or units that inspection and tests indicate would probably fail before the next scheduled periodic service. Preventive maintenance checks and services of the test facility set

at the organizational category are made monthly and quarterly unless otherwise directed by the commanding officer.

b. Maintenance forms and records to be used and maintained on this equipment are specified in TM 38-750.

5-4. Organizational Preventive Maintenance Checks and Services Periods

Organizational preventive maintenance checks and services of the test facility set are required monthly and quarterly.

a. Perform the maintenance functions indicated in the monthly preventive maintenance checks and services chart (para 5-) once each month. A month is defined as approximately 30-calendar days of 8-hour-per-day operation. If the equipment is operated 16 hours a day, the monthly preventive maintenance checks and services should be performed at intervals of 15 days. Adjustment of the maintenance interval must be made to compensate for any unusual operating conditions. Equipment maintained in a standby (ready for immediate operation) condition must have monthly preventive maintenance checks and services. Equipment in limited storage (requires service before operation) does not require monthly preventive maintenance.

b. Quarterly preventive maintenance checks and services are required. Periodic daily and monthly services constitute a part of the quarterly preventive maintenance checks and services and must be performed concurrently. All deficiencies of shortcomings will be recorded in accordance with the requirements of TM 38-750. Perform all the checks and services listed in the quarterly preventive maintenance checks and services chart (para 5-6) once every 3 months.

Section II. ORGANIZATIONAL PREVENTIVE MAINTENANCE

5-5. Organizational Monthly Preventive Maintenance Checks and Service Chart

Seq No.	Item	Procedure	Reference
1	Transmitter test facility	Remove test facility from case. Remove front panel from chassis..... Check all surfaces, for dirt, fungus, corrosion, and rust Remove dirt and fungus..... Remove corrosion and rust; touch up paint as necessary.....	Para 5-9 Para 4-5. Para 5-7.
2	Receiver test facility.....	Repeat sequence No.1 procedure.	
3	Accessory kit.....	Remove accessories from case. Check all surfaces for dirt, fungus, corrosion, and rust. Remove dirt and fungus..... Remove corrosion and rust; touch up paint as necessary.....	Para 4-5. Para 5-7.
4	Hardware.....	Check to see that all handles, bolts, nuts, and washers are present and properly tightened. Check for cracked, bent, or broken brackets. Report any irregularities to higher category maintenance.	
5	Connections	Check to see that connectors are properly mated and secure	Para 5-9.
6	Fuses	Check for correct fuses as follows: a. Two 3-ampere fuses on transmitter test facility front .. panel. b. Three 5-ampere fuses on accessory kit power supply.	Fig. 3-1. Fig. 3-3.
7	Publications.....	Check to see that all publications are complete, DA Pam 310-1. serviceable, and current.	
8	Modifications	Check to determine if new applicable MWO's haveTM 38-750 and been published. All URGENT MWO's must be applied... immediately. All NORMAL MWO's must be scheduled.	DA Pam 310-1.
9	Spare parts.....	Check all spare parts for general condition and..... method of storage. There should be no evidence of over stockage, and all shortages must be on valid requisitions.	Appx B.
10	RF modules test facility.	Remove the front panel as follows: a. Loosen the eight captive screws that secure the front panel to the case. b. Carefully pull the front panel directly away from the case. Check all surfaces, for dirt, fungus, corrosion, and rust. Remove dirt and fungus..... Remove corrosion and rust; touch up paint as necessary.....	Para 4-5. Para 5-7.
11	Accessory kit, band 2, 3, 4	Remove accessories from case. Check all surfaces for dirt, fungus, corrosion, and rust. Remove dirt and fungus	Para 4-5. Para 5-7.

5-6. Organizational Quarterly Preventive Maintenance Checks and Services Chart-Continued

Seq No.	Item	Procedure	Reference															
7	AMPL FREQ MULTIPLIER section.	<p>a. Connect J17 to J19 with RF cable assembly 335-279. Connect adapter CE9307-15 to J20 pin 2 and connect the adapter to J52, using RF cable assembly 335-277.</p> <p>b. Set S20 to position S12 and S12 to OSC. Check to see that LOW PWR and SYNC indicators light.....12 and 13.</p> <p>c. Set S18 to positions 47.50 through 72.50 and check to see that LOW PWR indicator lights. AMPL FREQ14 and 15. MULTIPLIER SYNC indicator does not light. SYNTHESIZER ON indicator lights and SYNTHESIZER SYNC indicator does not light.</p> <p>d. Observe meter MI as S12 is set to the positions shown:</p> <table border="0"> <tr> <td><i>Sw S12pos</i></td> <td><i>Other switch pos</i></td> <td><i>Meter indication</i></td> </tr> <tr> <td>OSC</td> <td>S18 to all pos.....</td> <td>..20 to 70.</td> </tr> <tr> <td>DBLR.....</td> <td>818 to all pos.....</td> <td>..20 to 70.</td> </tr> <tr> <td>REF</td> <td>S15 to DRIVER.....</td> <td>..50 to 80.</td> </tr> <tr> <td>REF</td> <td>S15 to OUTPUT.....</td> <td>..50 to 80.</td> </tr> </table> <p>e. Set S18 to OFF and check to see that SYN-..... THESIZER ON indicator goes out and that AMPL FREQ MULTIPLIER SYNC indicator lights.</p> <p>f. Set S12 to OFF. Disconnect RF cable assemblies and adapter (a above).</p>	<i>Sw S12pos</i>	<i>Other switch pos</i>	<i>Meter indication</i>	OSC	S18 to all pos.....	..20 to 70.	DBLR.....	818 to all pos.....	..20 to 70.	REF	S15 to DRIVER.....	..50 to 80.	REF	S15 to OUTPUT.....	..50 to 80.	<p>Fig. 3-1.</p> <p>Para 5-8b, items</p> <p>Para 5-8b, items</p> <p>Para 5-8b, item 16.</p> <p>Para 5-8b, item 18.</p> <p>Para 5-8b, item 13.</p>
<i>Sw S12pos</i>	<i>Other switch pos</i>	<i>Meter indication</i>																
OSC	S18 to all pos.....	..20 to 70.																
DBLR.....	818 to all pos.....	..20 to 70.																
REF	S15 to DRIVER.....	..50 to 80.																
REF	S15 to OUTPUT.....	..50 to 80.																
8	SYNTHESIZER section Set	S17 to ON; S18 to 47.50 and check to see that ON indicator lights. Set S17 and S18 to OFF.																
9	FAN section Operate S19 to TEST and check to see that the fan stops running. Release S19 and check to see that fan runs.																
10	CONTROL ALARM section	<p>a. Connect multimeter to J32 and J35. Turn SET INPUT control fully counterclockwise. Set S25 to ON.</p> <p>b. Turn SET INPUT control fully clockwise and check to see that multimeter indicates from 0 to at least 0.5 volt.</p> <p>c. Set S25 to OFF and disconnect multimeter.</p>																
11	POWER section.....	Set S1 to OFF. <i>TEST FACILITY, RECEIVER</i> <i>TS-2867(V)21GRM-95(V)</i>																
12	Power section indicators and power supply metering.	Set S1 to ON; AC, +12 V, and + 26 V indicators should light. Check the power supply by observing meter M as S5 is set to the positions shown:	Para 5-8b, items															
13	30 MHz MODEM power supply metering.	<table border="0"> <tr> <td><i>Sw S5pos</i></td> <td><i>Meter indication</i></td> </tr> <tr> <td>-12V.....</td> <td>Green band.</td> </tr> <tr> <td>+12V.....</td> <td>Green band.</td> </tr> <tr> <td>+26 V.....</td> <td>Green band.</td> </tr> </table>	<i>Sw S5pos</i>	<i>Meter indication</i>	-12V.....	Green band.	+12V.....	Green band.	+26 V.....	Green band.								
<i>Sw S5pos</i>	<i>Meter indication</i>																	
-12V.....	Green band.																	
+12V.....	Green band.																	
+26 V.....	Green band.																	
14	30 MHz MODEN	Set S5 to -12V MODEM and check to see that meter M1 indicates in the green band.	Para 5-8b, item 20.															
15	POWER SUPPLY section.	Set S5 to S9 MODEM and observe meter MI as S9 is set to the positions shown:																
16	TUNER RADIO FREQ.....	<table border="0"> <tr> <td><i>Sw S5pos</i></td> <td><i>Meter indication</i></td> </tr> <tr> <td>100 Hz.....</td> <td>Green band.</td> </tr> <tr> <td>1 KHz</td> <td>Green band.</td> </tr> <tr> <td>50 KHz</td> <td>Green band.</td> </tr> <tr> <td>30 MHz.....</td> <td>Green band.</td> </tr> </table>	<i>Sw S5pos</i>	<i>Meter indication</i>	100 Hz.....	Green band.	1 KHz	Green band.	50 KHz	Green band.	30 MHz.....	Green band.	Para 5-8b, item 21.					
<i>Sw S5pos</i>	<i>Meter indication</i>																	
100 Hz.....	Green band.																	
1 KHz	Green band.																	
50 KHz	Green band.																	
30 MHz.....	Green band.																	
16	TUNER RADIO FREQ.....	<p>a. Connect J14 to J10 with RF cable assembly 335-279. Connect the adapter to J12 pin A2.</p>	Fig. 3-1.															

5-6. Organizational Quarterly Preventive Maintenance Checks and Services Chart-Continued

Seq No.	Item	Procedure	Reference												
16 (Cont.)		<p>b. Set S6 to OSC and check to see that SYNC indicator lights.</p> <p>c. Set S8 to all positions from 47.50 to 72.50 and check to see that SYNTHESIZER section indicator lights and 23 and 24. SYNC indicator does not light.</p> <p>d. Set S5 to position S6. Set S8 to all positions from 47.50 to 72.50 and check to see that meter M1 indicates between 30 and 80 in all positions.</p> <p>e. Set S6 to DBLR. Set S8 to all positions from 47.50 to 26. 72.50 and check to see that meter M1 indicates between 30 and 80 in all positions.</p> <p>f. Set S6 and S8 to OFF. Disconnect RF cable assembly termination and adapter (a above).</p>	<p>Para 5-8b, item 22.</p> <p>Para 5-8b, items</p> <p>Para 5-8b, item 25.</p> <p>Para 5-8b, item</p>												
17	ELECTRONIC SWITCH section.	<p>a. Connect J50 to J51 with cable assembly 457-574. Set S5 to position S17.</p> <p>b. Observe meter M1 as S17 is set to the positions..... shown.</p> <table border="0" data-bbox="475 737 954 884"> <tr> <td><i>Sw S17pos</i></td> <td><i>Meter indication</i></td> </tr> <tr> <td>+12V</td> <td>Green band.</td> </tr> <tr> <td>-12V</td> <td>Green band.</td> </tr> <tr> <td>100 V</td> <td>30 to 50.</td> </tr> <tr> <td>200 V</td> <td>Green band.</td> </tr> <tr> <td>6 V</td> <td>Green band</td> </tr> </table>	<i>Sw S17pos</i>	<i>Meter indication</i>	+12V	Green band.	-12V	Green band.	100 V	30 to 50.	200 V	Green band.	6 V	Green band	<p>Fig. 3-1</p> <p>Para 5-8b, item 27.</p>
<i>Sw S17pos</i>	<i>Meter indication</i>														
+12V	Green band.														
-12V	Green band.														
100 V	30 to 50.														
200 V	Green band.														
6 V	Green band														
18	Power section.....	<p>c. Set S17 to ALARM TEST, set S18 to NORMAL, and.. disconnect the cable assembly (a above).....27 and 28. Set S1 to OFF.</p> <p><i>RADIO FREQUENCY MODULES FACILITY TS-3837(V)2/GRM-95(V)2</i></p>	<p>Para 5-8b, items</p>												
19	REGULATOR VOLTAGE section.	<p>a. Connect Lambda LK342-FM power supply to J1 (+) and J2 (-), using test lead 276-800020-000 (3 ft).</p> <p>b. Set power supply output to + 13 volts ± 1 volt.</p> <p>c. Set S1 to ON; SUPPLY indicator should light.....</p> <p>d. Connect multimeter to J7 pins 2 (+) and 10 (-).</p> <p>e. Set S4 to OFF, S5 to 0 OHM and S2 to 6.4 V.</p> <p>f. Press and hold S6; the multimeter should indicate 6.4 V dc.</p> <p>g. Set S2 to 7.2 V and 8.0 V alternately, the multimeter . should indicate 7.2 V dc ±2 V and 8.0 V dc ±0.2 V respectively.</p> <p>h. Release S6, disconnect multimeter and set S1 to OFF.</p> <p>i. Disconnect power supply.</p>	<p>Para 5-8b, item 29.</p> <p>Para 5-8b, item 30.</p> <p>Para 5-8b, item 30.</p>												
20	CONV FREQ ELECTRONIC section. ...	<p>a. Connect receiver test facility J12 to RF modules test facility J29 using Cable Assembly CX-12061/U (3 ft).</p> <p>b. Set receiver test facility switches S1 to ON and S6 to OSC; the 12 V lamp should illuminate.</p> <p>c. Connect multimeter to J9 pins 1 (+) and 2 (-); the multimeter should indicate + 12 V dc ±F0.1 volt.</p> <p>d. Connect multimeter to J9 pins 8 (+) and 5 (-); the multimeter should indicate ± 26 V dc : ±2 volts.</p> <p>e. Set receiver test facility switches S1 to OFF and S6 to OFF and disconnect cable between test facilities.</p>	<p>Para 5-8b, item 31.</p> <p>Para 5-8b, item 32.</p> <p>Para 5-8b, item 32.</p>												
21	AMPLIFIER RADIO FREQUENCY section.	<p style="text-align: center;">WARNING</p> <p>Hazardous voltages exist at RF modules test facility connector J16 pin A1.</p> <p>a. Connect transmitter test facility J20 to RF modules test facility J28 using Cable Assembly CX-12028FU (3 ft).</p> <p>b. On RF modules test facility, shortcircuit J16 pins 3 and 4, and pins 8 and 9.</p> <p>c. Set transmitter test facility switches as follows:</p>													

5-6. Organizational Quarterly Preventive Maintenance Checks and Services Chart-Continued

Seq No.	Item	Procedure	Reference										
21 (Cont.)		<table border="0"> <tr> <td>Switch</td> <td>Position</td> </tr> <tr> <td>S1</td> <td>ON</td> </tr> <tr> <td>S12</td> <td>OSC</td> </tr> <tr> <td>S13</td> <td>600 V ON</td> </tr> <tr> <td>S20</td> <td>+600V</td> </tr> </table> <p>d. Set RF modules test facility switches S10 to DRIVER FIL and S8 to ON. The DRIVER FIL and OUTPUT FIL lamps should light.</p> <p>e. Set RF modules test facility switch S9 to 600 V ON ... the 600 V lamp should illuminate. Transmitter test facility meter M1 should indicate 40 percent minimum.</p> <p>f. Set transmitter test facility switches S13 to the off position and S1 to OFF.</p>	Switch	Position	S1	ON	S12	OSC	S13	600 V ON	S20	+600V	<p>Para 5-8b, item 33.</p> <p>Para 5-8b, item 34.</p>
Switch	Position												
S1	ON												
S12	OSC												
S13	600 V ON												
S20	+600V												
22	FILTER BANDPASS section.	<p>a. Connect receiver test facility J52 to RF modules test facility J17 using Cable Assembly CG-409H/U (3 ft).</p> <p>b. Connect Power Meter HP-435A to RF modules test facility J18 through Thermistor Mount HP-8484A and Adapter-Connector UG-349A/U.</p> <p>c. Set receiver test facility switches as follows:</p> <table border="0"> <tr> <td>Switch</td> <td>Position</td> </tr> <tr> <td>S1</td> <td>ON</td> </tr> <tr> <td>AT1</td> <td>30</td> </tr> <tr> <td>S14</td> <td>30 MHz</td> </tr> <tr> <td>S9</td> <td>EXT VIDEO</td> </tr> </table> <p>d. The power meter should indicate -42 dBm or higher, . indicating an insertion loss of 12 dB maximum.</p> <p>e. Set receiver test facility switch S1 to OFF and disconnect test equipment.</p>	Switch	Position	S1	ON	AT1	30	S14	30 MHz	S9	EXT VIDEO	<p>Para 5-8b, item 35.</p>
Switch	Position												
S1	ON												
AT1	30												
S14	30 MHz												
S9	EXT VIDEO												
23	AMPLIFIER, RF section.	<p>a. Connect receiver test facility J21 to RF modules test facility J29 using Cable Assembly CX- 12061/U (3 ft).</p> <p>b. Set receiver test facility switches S1 to ON and S6 to OSC.</p> <p>c. Set RF modules test facility switch S11 to NOR-..... MAL; the + 12 V lamp should light.</p> <p>d. Connect multimeter to RF modules test facility J25.... pins 3 (-) and 6 (+); the multimeter should indicate +12 V dc±0.5 volt.</p> <p>e. Connect multimeter to J25 pins 1 (+) and 6 (-); the multimeter should indicate + 12 V dc + 0.5 volt.</p> <p>f. Set receiver test facility switch S1 to OFF and disconnect Cable Assembly CX-12061/U.</p>	<p>Para 5-8b, item 36.</p> <p>Para 5-8b, item 37.</p> <p>Para 5-8b, item 37.</p>										
24	AMPLIFIER, IF section.	<p>a. Connect receiver test facility J52 and J12 to RF modules test facility J30 and J29 using Cable Assemblies CG-409H/U (3 ft) and CX-12061/U (3 ft) respectively.</p> <p>b. Set receiver test facility switches as follows:</p> <table border="0"> <tr> <td>Switch</td> <td>Position</td> </tr> <tr> <td>S1</td> <td>ON</td> </tr> <tr> <td>S9</td> <td>EXT VIDEO</td> </tr> <tr> <td>S14</td> <td>30 MHz</td> </tr> <tr> <td>AT1</td> <td>60</td> </tr> </table> <p>c. Connect Power Meter HP-435A to RF modules test facility J31 through Thermistor Mount HP-8484A and Adapter-Connector UG-349AIU.</p> <p>d. Set RF modules test facility switch S12 to ON, the power meter should indicate -10 dBm +3 dB, and the - 12 V lamp should light.</p> <p>e. Set receiver test facility switch S1 to OFF and disconnect test equipment.</p>	Switch	Position	S1	ON	S9	EXT VIDEO	S14	30 MHz	AT1	60	<p>Para 5-8b, item 38.</p>
Switch	Position												
S1	ON												
S9	EXT VIDEO												
S14	30 MHz												
AT1	60												

5-6. Organizational Quarterly Preventive Maintenance Checks and Services Chart-Continued

Seq No.	Item	Procedure	Reference
25	AMP FREQ MULT section.	<p>a. Connect transmitter test facility J20 to RF modules test facility J28 using Cable Assembly CX-12028/U (3 ft).</p> <p>b. Set transmitter test facility switches S1 to ON and S6 to ON.</p> <p>c. Set RF modules test facility switch S13 to ALC 1 and shortcircuit J32 and J33. The + 28 V lamp should light.</p> <p>d. Connect multimeter between J36 pin 1 (+) and J36 pin 5 (-) of the RF modules test facility; the multimeter should indicate + 28 V dc + 2 volts.</p> <p>e. Remove shortcircuit from J32 to J33, and connect multimeter between J36 pin 15 (+) and J36 pin 14 (-), it should read + 26 V dc + 2 volts.</p> <p>f. Set transmitter test facility switch S1 to OFF, and disconnect Cable Assembly CX-12028/U.</p>	<p>Para 5-8b, item 39.</p> <p>Para 5-8b, item 40.</p> <p>Para 5-8b, item 40.</p>
26	AMP FREQ MULTIPLIER section	<p>a. Connect transmitter test facility J20 to RF modules test facility J28 using Cable Assembly CX-12028/U (3 ft).</p> <p>b. Set transmitter test facility switches S1 to ON and S6 to OSC.</p> <p>c. Set RF modules test facility switch S14 to NORMAL, and shortcircuit connectors J38 and J39. The +28 V lamp should illuminate.</p> <p>d. Connect multimeter between J42 pin (+) and pin (-) of the RF modules test facility. The multimeter should indicate + 28 V dc +0.5 V dc.</p> <p>e. Connect multimeter between J42 pin 13 (+) and pin 14 (-). The multimeter should indicate 0 volt ±0.1 volt.</p> <p>f. Set switch S14 to X 16, the multimeter should indicate + 26 V dc ±2 volts.</p> <p>g. Set transmitter test facility switch S1 to OFF, and disconnect Cable Assembly CX- 12028/U.</p>	<p>Para 5-8b, item 39.</p> <p>Para 5-8b, item 41.</p> <p>Para 5-8b, item 41.</p> <p>Para 5-8b, item 41.</p>
27	FREQUENCY MULTIPLIER section	<p>a. Connect receiver test facility J12 to RF module test facility J29 using Cable Assembly CX-12061/U (3 ft).</p> <p>b. Set receiver test facility switches S1 to ON and S6 to OSC.</p> <p>c. Set RF modules test facility switch S15 to NORMAL. The +12 V lamp should illuminate.</p> <p>d. Connect the multimeter between J46 pins 1 (+) and 2 (-) of the RF modules test facility. The multimeter should indicate + 12 V dc +0.5 volt.</p> <p>e. Set receiver test facility switch S1 to OFF.</p>	<p>Para 5-8b, item 42.</p> <p>Para 5-8b, item 43.</p>
28	Adapter-connectors in units 4 and 5.	Check continuity of the center conductors and ensure that the center conductors are not shorted to the outer shell.	Para 5-8b, item 44.
29	Waveguide probes in units 4 and 5.....	Repeat sequence No. 28 procedure.	Para 5-8b, item 44.
30	Short circuit terminations.	Check continuity of the center conductor to the outer shell.	Para 5-8b, item 44.
31	Special purpose electrical cable Assemblies	<p>a. Refer to figures 5-1 through 5-10 and using the . multimeter, check the continuity of all pins between the connectors of each cable.</p> <p>b. Use Insulation Tester AN/GSM-6 set for 500 V and check the insulation between pins.</p>	Para 5-8b, item 45.
32	RF cable assemblies.	Check continuity of the center conductors and ensure that the center conductors are not shorted to the shield.	Para 5-8b, item 45.

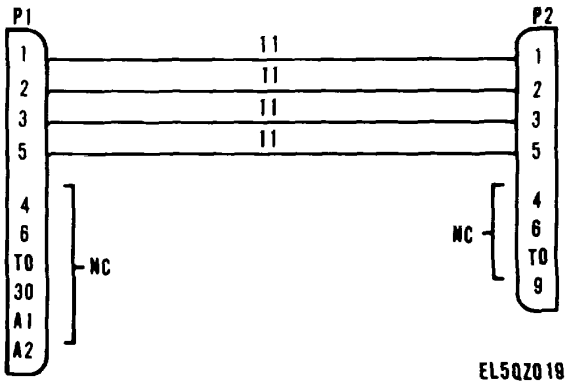

Figure 5-1. Cable Assembly, Special Purpose, Electrical 217-803023-000(4W1), Wiring Diagram.

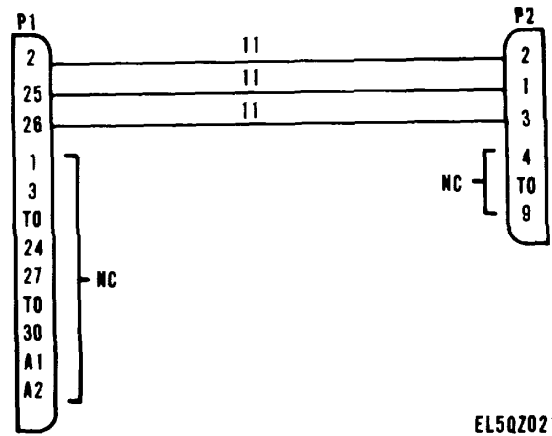

Figure 5-3. Cable Assembly, Special Purpose, Electrical 217-803023-000(4W3), Wiring Diagram.

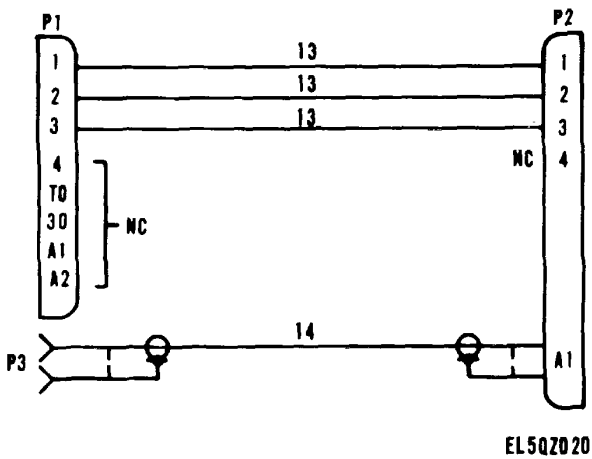

Figure 5-2. Cable Assembly, Special Purpose, Electrical 217-803023-000(4W2), Wiring Diagram.

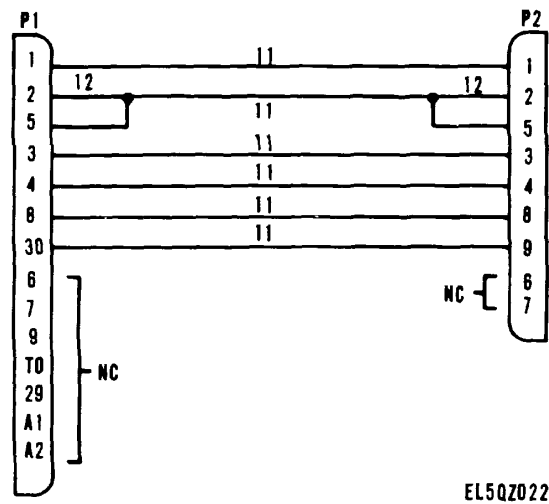

Figure 5-4. Cable Assembly, Special Purpose, Electrical 217-803023-000(4W4), Wiring Diagram.

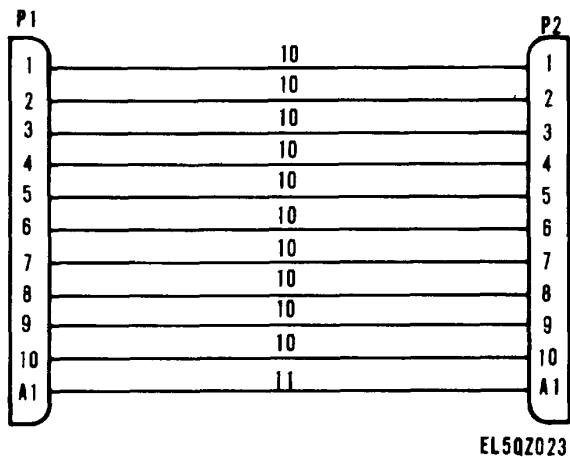

Figure 5-5. Cable Assembly, Special Purpose, Electrical 217-803028-000 (4W5), Wiring Diagram.

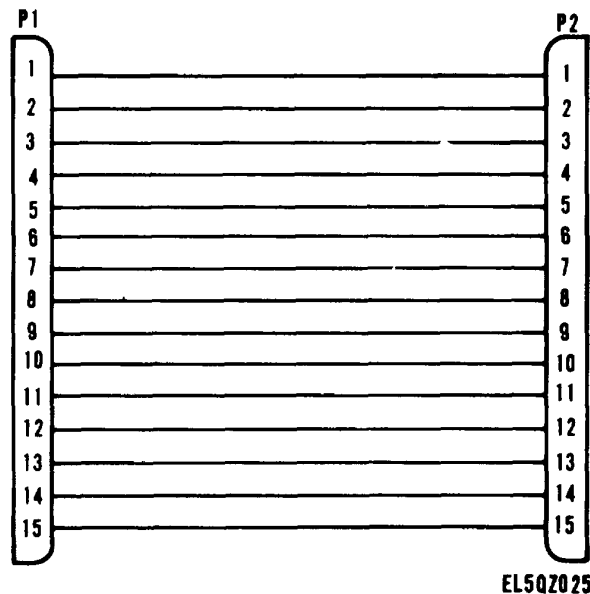

Figure 5-7. Cable Assembly, Special Purpose, Electrical 217-803030-000 (4W7), or 217-8030001 (1W40), Wiring Diagram.

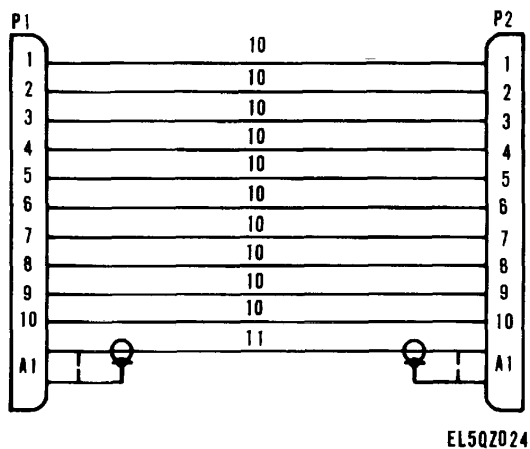

Figure 5-6. Cable Assembly, Special Purpose, Electrical 217-803029-000 (4W6), Wiring Diagram.

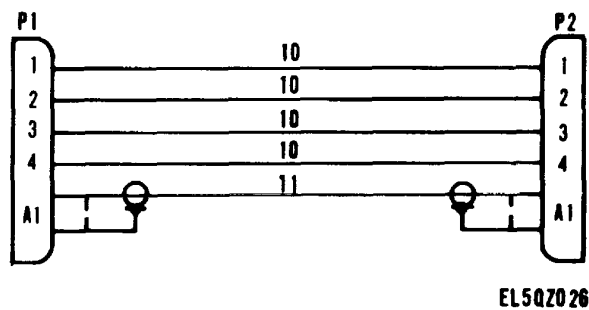

Figure 5-8. Cable Assembly, Special Purpose, Electrical 217-803031-000 (4W8), Wiring Diagram

5-7. Touchup Painting Instructions

Remove rust and corrosion from metal surfaces by lightly sanding them with fine sandpaper. Brush two thin coats of paint on the bare metal to protect it from further corrosion. Refer to applicable cleaning and refinishing practices specified in TB 43-0118.

5-8. Organizational Troubleshooting Chart

a. General. The troubleshooting chart is based on the checks contained in the quarterly preventive maintenance checks and services chart (para 5-6). To troubleshoot the equipment, perform all

the checks in paragraph 5-6 and proceed through the checks until an abnormal condition or result is observed. When an abnormal condition or result is observed, the *References* column refers to the appropriate symptom(s) in the troubleshooting chart. If no reference is given, higher category of maintenance is required. If the corrective measures listed in the troubleshooting chart do not result in correction of the trouble, higher category of maintenance is required. Paragraph 5-26 contains additional troubleshooting and replacement information.

b. Troubleshooting.

Item No.	symptom	Probable cause	Checks and Corrective measure
1	AC POWER indicator does not light and VOLTS meter indicates 115 volts.	<i>POWER SUPPLIY</i> <i>PP-6304/GRM-95(V)2</i> Defective lamp	Check lamp; replace as necessary (para 4-6a).
2	AC POWER indicator does not light and VOLTS meter does not indicate.	Defective lamp (para 4-6b).	Check fuses; replace as necessary
3	POWER section AC indicator does not light.	<i>TEST FACILITY,</i> <i>TRANSMITTER TS-2866/(V)2/</i> <i>GRM-95(V)2</i> Defective lamp	Check lamp; replace if necessary (para 4-6a).
4	One or both POWER section + 12 V and + 28 V indicators do not light.	Defective lamp(s)	Check lamp(s); replace if necessary (para 4-6a).
5	POWER section + 12 V and + 28 V indicators do not light and fan does not run.	a. Defective interlock	a. Check interlocks (para 5-26a).
		b. Defective time delay assemblyb.	Check power supply metering (para 5-6, sequence No. 3) and set S2 to ON. If power supply metering indications are zero, and PWR SUP TEST indicator does not light, set S1 and S2 to off position and replace time delay assembly (para 5-11).
6	a. Defective interlock	c. Defective power supply sub- assembly. a. Check interlocks..... b. Defective fan	c. Replace power supply (para 26b). (para 5-26a). b. Replace fan (para 5-17).
		c. Defective power supply sub- assembly. d. Defective cable assembly 457-565. (fig. 3-1).	c. Replace power supply (para 26b). d. Replace cable assembly 457-565
7	Power supply metering abnormal	Defective power supply subassembly.	Replace power supply (para 5-26b).
8	26 V SUPPLY section indicator does not light.	Defective lamp	Check lamp; replace as necessary (para 4-6a).
9	26 V SUPPLY section indicator does not light and 0 volt at J14 and J59.	Defective fuse	Check fuse; replace as necessary (para 4-6b).
10	PWR SUP TEST indicator does not light.	Defective lamp	Check lamp; replace as necessary (para 4-6a).
11	600 volts metering abnormal	Defective power supply subassembly .	Replace powr supply (para 26b).
12	LOW PRW indicator does not light	Defective lamp	Check lamp; replace if necessary (para 4-6a).
13	AMPL FREQ MULTIPLIER SYNC indicator does not light.	a. Defective lamp	Check lamp; replace if necessary (para 4-6a).
		b. Defective synthesizer.....	Replace synthesizer (para 5-12).

b. Troubleshooting

Item No.	symptom	Probable cause	Checks and Corrective measure
14	SYNTHESIZER section On indicator does not light.	Defective lamp	Check lamp, replace as necessary (para 4-6a).
15	AMPLIFREQMULTIPLIER section SYNC indicator lights.	a. Defective diode matrix..... b. Defective synthesizer.....	a. Replace diode matrix(para 5-10). b. Replace synthesizer (para 5-12).
16	S12 OSC meter indication abnormal	Defective synthesizer.....	Replace synthesizer (para 5-12).
17	S12 DBLR meter indication abnormal	Defective amplifier-frequency multiplier. <i>TEST FACILITY, RECEIVER TS-2867(V)2/GRM-95(V)2</i>	Replace amplifier-frequency multiplier (para 5-13).
18	AC,-12 V, +12 V, or +26 V indicator does not light; power supply metering normal.	Defective lamp(s)	Check lamp(s); replace if necessary (para 4-6a).
19	Power supply metering abnormal	Defective power supply sub-assembly.	Replace power supply (para 5-26c).
20	MODEM metering abnormal	Defective modem	Replace modem (para 5-20).
21	POWER SUPPLY section indicator does not light.	Defective lamp	Check lamp; replace if necessary (para 4-6a).
22	RADIO FREQ TUNER section SYNC indicator does not light.	a. Defective lamp	a. Check lamp; replace if necessary (para 4-6a).
23	SYNTHESIZER section indicator does not light	b. Defective synthesizer.....	b. Replace synthesizer (para 5-21).
24	SYNC indicator lights.....	Defective lamp	Check lamp, replace as necessary (para 4-6a).
25	S6 OSC metering abnormal.....	a. Defective diode matrix.....	a. Replace diode matrix (para 5-18).
26	S6 DBLR metering abnormal	b. Defective synthesizer.....	b. Replace synthesizer (para 5-21).
27	ELECTRONIC SWITCH metering abnormal.	Defective synthesizer.....	Replace synthesizer (para 5-21).
28	ALARM TEST indicator does not... light.	Defective amplifier-frequency multiplier.	Replace amplifier-frequency multiplier (para 5-25).
29	SUPPLY indicator does not light ...	a. Defective power supply	Replace power supply (para 5-24).
30	Abnormal meter indications	b. Defective dummy load assembly (para 5-19).	b. Replace dummy load assembly (para 5-19).
31	±12 V indicator does not light.....	Defective lamp	Check lamp, replace as necessary (para 4-6a).
32	Abnormal meter indications	<i>RF MODULES FACILITY TS-3837(V)2/GRM-95(V)2</i>	
33	DRIVER FIL or OUTPUT FIL lamp does not illuminate.	Defective lamp	Check lamp, replace if necessary.
34	600 V lamp does not illuminate,.... M1 on transmitter test facility indication abnormal.	a. Defective circuit card assembly No. 1. b. Defective heat sink component assembly.	a. Replace circuit card assembly No. 1 (para 5-27). b. Replace heat sink component assembly (para 5-28).
35	Power meter indication abnormal..	Defective lamp	Check lamp, replace if necessary.
36	± 12 V lamp does not illuminate	Defective switch S7	Higher category maintenance required.
37	Abnormal meter indications	Defective lamp	a. Check lamps and replace as necessary.
38	Abnormal power meter indication..	b. Defective voltage regulator	b. Replace voltage regulator (para 5-29).
39	+ 28 V lamp does not illuminate....	Defective circuit card assembly	Replace circuit card assembly No. 2 (para 5-30).
40	Abnormal meter indication.....	Defective bandpass filter	Replace bandpass filter (para 5-31).
		Defective lamp	Check lamp, replace if necessary.
		Defective switch S11	Higher category maintenance required.
		a. Defective IF. Amplifier	a. Replace IF. amplifier (para 5-32).
		b. Defective circuit card assembly No. 3.	b. Replace circuit card assembly No. 3 (para 5-33).
		Defective lamp	Check lamp, replace if necessary.
		Defective switch S13	Higher category maintenance required.

b. Troubleshooting

Item No.	symptom	Probable cause	Checks and Corrective measure
41	Abnormal meter indication.....	Defective switch S14.....	Higher category maintenance re- quired.
42	+ 12 V lamp does not illuminate....	Defective lamp	Check lamp, replace if necessary.
43	Abnormal meter indication.....	Defective switch S15.....	Higher category maintenance required.
44	Abnormal insulation test	Defective component.....	Discard defective component.
45	Abnormal insulation test	Open or shorted connector or..... conductor.	Disassemble connector and repair or replace broken conductor.

Section III. ORGANIZATIONAL REPLACEMENT OF ASSEMBLIES

5-9. General Replacement Procedures

CAUTIONS

Do not twist an assembly to ease removal. Always lift assemblies directly away from mounting surfaces. Be sure connectors are properly mated before securing an assembly. Do not attempt to force connectors together with retaining screws or sliding locks.

a. Transmitting test facility assemblies replacement procedures are given in paragraphs 5-10 through 5-17. Receiver test facility assemblies replacement procedures are given in paragraphs 5-18 through 5-25. RF modules test facility assemblies replacement procedures are given in paragraphs 5-27 through 5-33.

b. Remove the transmitter or receiver test facility front panel as follows:

- (1) Loosen the eight captive screws that secure the front panel to the rear chassis.
- (2) Carefully pull the front panel directly away from the rear chassis as far as the slides permit.
- (3) Lift the front panel out of the slides.

c. Replace the transmitter or receiver test facility front panel as follows:

CAUTION

When replacing the transmitter front panel, be sure that the short flexible hose at the rear of the panel fits over the rigid tube protruding from the chassis.

- (1) Place the front panel hooks on the slide posts.
- (2) Carefully push the front panel toward the rear chassis until the connectors mate.
- (3) Tighten the eight captive securing screws.

5-10. Replacement of Semiconductor Device Assembly, Diode 220-801225-000 (fig. 5-11)

a. Remove the transmitter test facility front panel (para 5-9b) and lay it face downward. Locate semiconductor device assembly, diode 220-801225-000.

b. Loosen the two captive screws on both diode matrix plugs and disconnect the plugs.

c. Loosen the four captive screws that secure the diode matrix to the panel and remove the matrix.

d. Aline the four captive screws of the replacement diode matrix with the mounting posts and tighten the screws.

e. Connect the two diode matrix plugs to their mating connectors and tighten the four captive screws.

f. Replace the front panel (para 5-8c).

5-11. Replacement of Time Delay Assembly 457-533 (fig. 5-11)

a. Remove the transmitter test facility front panel (para 5-9b) and lay it face downward. Locate time delay assembly 457-533.

b. Loosen the two captive screws on the time delay assembly plug and disconnect the plug.

c. Loosen the three captive screws that secure the time delay assembly to the panel and remove the assembly.

d. Aline the three captive screws of the replacement time delay assembly with the mounting posts and tighten the screws.

e. Connect the time delay assembly plug to its mating connector and tighten the two captive screws.

f. Replace the front panel (para 5-9c).

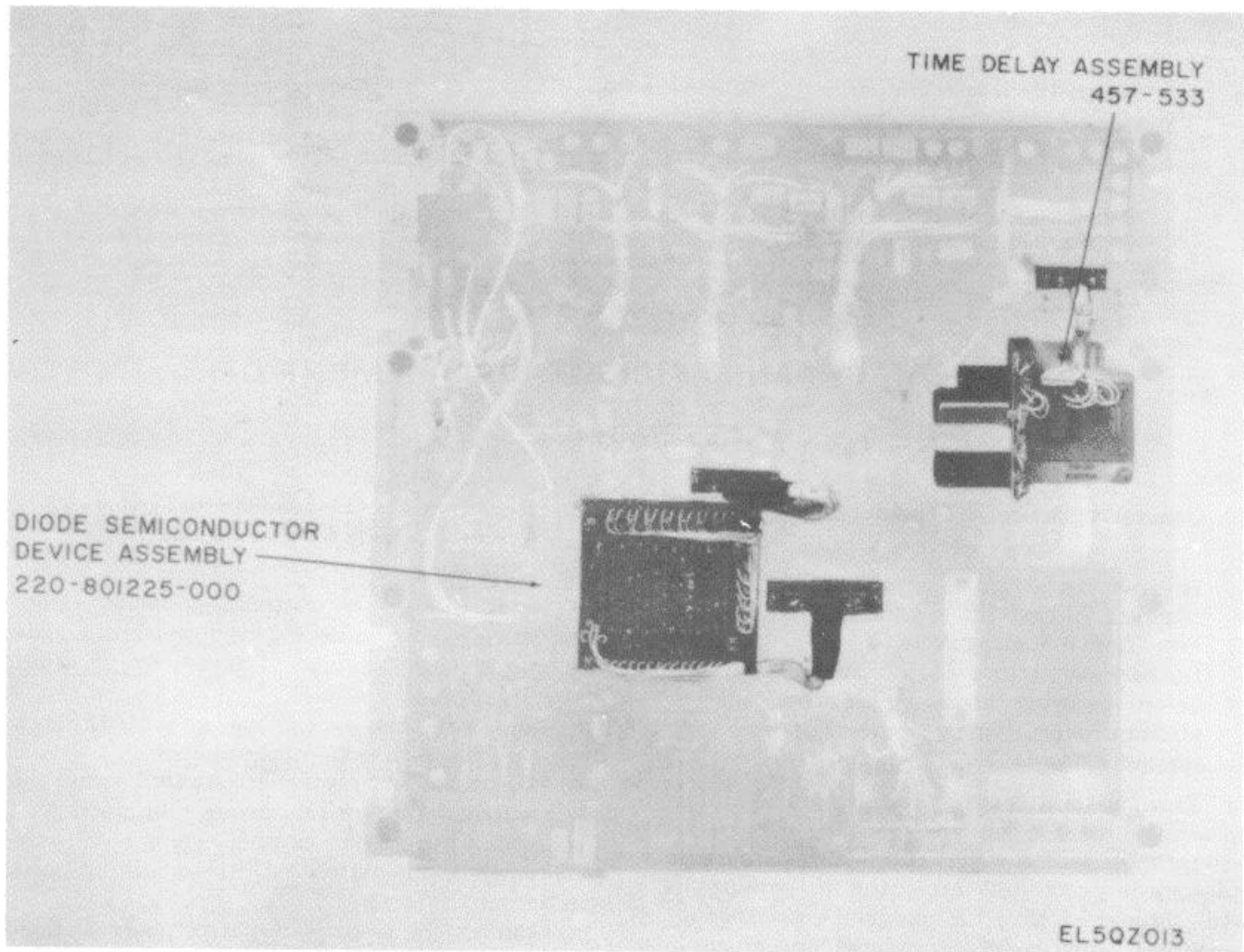

Figure 5-11. Transmitter Test Facility Panel Rear View.

5-12. Replacement of Electrical Frequency Synthesizer 245-800202-000 (fig. 5-12)

a. At the rear of the transmitter test facility chassis, locate electrical frequency synthesizer 245-800202-000 and electrical connector bracket P1.

b. Loosen the two screws that secure the bracket to the chassis. Disconnect P1 from J11 by sliding the bracket away from the synthesizer.

c. Loosen the four captive screws and pull the synthesizer directly away from the chassis.

d. Carefully position the replacement synthesizer, engage the chassis connector, and tighten the four captive screws.

e. Connect P1 to J11 and tighten the two bracket screws.

5-13. Replacement of Amplifier-Frequency Multiplier 407-070 (fig. 5-12)

a. At the rear of the transmitter test facility chassis, locate amplifier-frequency multiplier 407-070.

b. Loosen the two captive screws and pull the amplifier-frequency multiplier directly away from the chassis.

c. Carefully position the replacement amplifier-frequency multiplier, engage the chassis connector, and tighten the two captive screws.

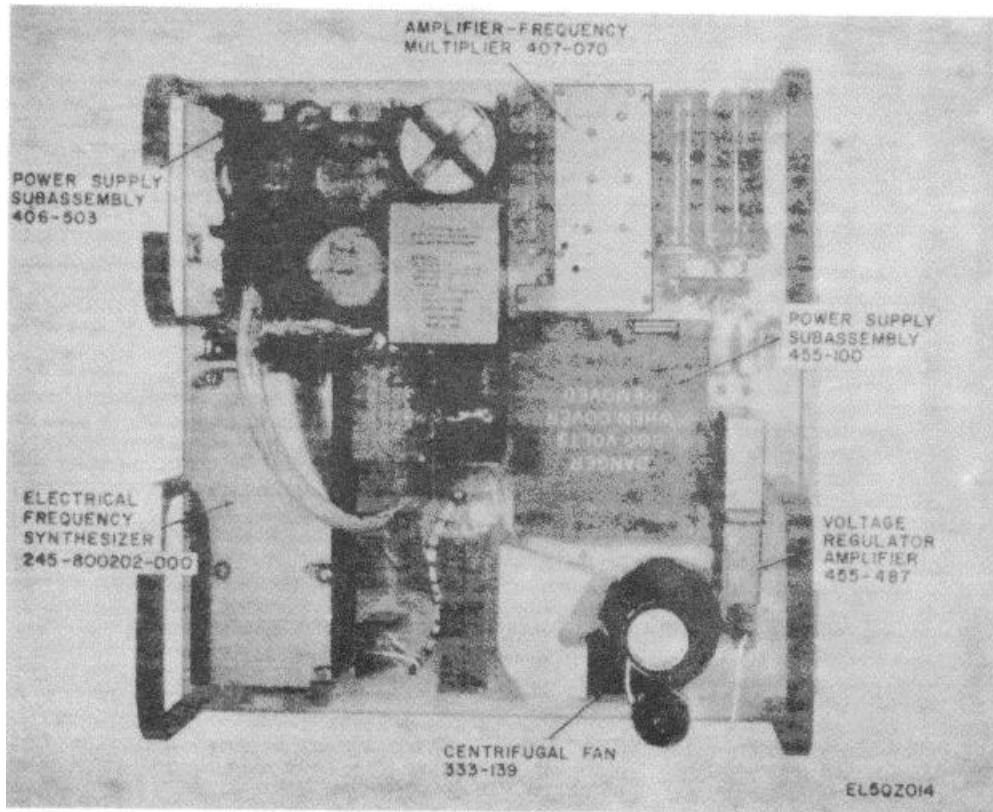

Figure 5-12. Transmitter Test Facility Chassis, Rear View.

5-14. Replacement of Power Supply Subassembly 406-503 (fig. 5-12)

- At the rear of the transmitter test facility chassis, locate power supply subassembly 406-503.
- Loosen the two captive screws on P6 and disconnect P6 from J2.
- Loosen the eight captive screws that secure the subassembly to the chassis and pull the subassembly directly away from the chassis.
- Carefully position the replacement power supply subassembly, engage the chassis connectors, and tighten the eight captive screws.
- Connect P6 to J2 and tighten the two captive screws.

5-15. Replacement of Power Supply Subassembly 455-100 (fig. 5-12)

- At the rear of the transmitter test facility chassis, locate power supply subassembly 455-100.
- Loosen the four captive screws that secure the

- Remove the two screws that secure the subassembly to the chassis.
- Pull the subassembly directly away from the chassis.
- Carefully position the replacement power supply subassembly, engage the chassis connector, and insert and tighten the two screws.
- Position the subassembly cover and tighten the four captive screws.

5-16. Replacement of Voltage Regulator Amplifier 455-487 (fig. 5-12)

- At the rear of the transmitter test facility chassis, locate voltage regulator amplifier 455-487.
- Remove the two screws that secure the voltage regulator amplifier retaining bracket. Remove the bracket.
- Pull the voltage regulator amplifier directly away from the chassis.
- Carefully position the replacement voltage regulator amplifier and engage the chassis connector.

e. Position the voltage regulator amplifier retaining bracket and insert and tighten the two screws.

5-17. Replacement of Centrifugal Fan 333-139 (fig. 5-12)

a. Remove the transmitter test facility front panel (para 5-9b).

b. At the rear of the transmitter test facility chassis, locate centrifugal fan 333-139.

c. Loosen the two captive screws that secure P1 to J3 and disconnect P1.

d. On the front of the transmitter test facility chassis, locate the three nuts that secure the fan to the chassis.

e. Remove the three nuts and washers and pull the fan directly away from the chassis.

f. Insert the three mounting bolts of the replacement fan through the holes in the chassis. Place the lockwashers on the bolts, start the nuts on the bolts, and tighten the nuts.

g. Connect P1 to J3 and tighten the two captive screws.

h. Replace the front panel (para 5-9c).

5-18. Replacement of Semiconductor Device Assembly Diode 220-801225-000 (fig. 5-13)

a. Remove the receiver test facility front panel (para 5-9b) and lay it face downward. Locate semiconductor device assembly diode 220-801225-000.

b. Loosen the two captive screws on both plugs and disconnect the plugs.

c. Loosen the four captive screws that secure the unit to the panel and remove the matrix.

d. Aline the four captive screws of the replacement unit with the mounting post and tighten the screws.

e. Connect the two plugs to their mating connectors and tighten the four captive screws.

f. Replace the front panel (para 5-9c).

5-19. Replacement of Dummy Load Assembly 456-694 (fig. 5-13)

a. Remove the receiver test facility front panel (para 5-9b) and lay it face downward. Locate dummy load assembly 456-694.

b. Loosen the two captive screws on the dummy load plug and disconnect plug.

c. Loosen the four captive screws that secure the dummy load to the panel and remove the dummy load.

d. Aline the four captive screws of the replacement dummy load with the mounting posts and tighten the screws.

e. Connect the dummy load plug to its mating connector and tighten the two captive screws.

f. Replace the front panel (para 5-9c).

5-20. Replacement of Modem 407-188

a. Locate the modem and loosen the four captive screws that secure the modem assembly to the receiver test facility front panel.

b. Withdraw the modem assembly and loosen the two captive screws that secure P7 to J 1. Disconnect P7.

c. Connect P7 to J1 on the replacement modem assembly, and tighten the two captive screws.

d. Insert the modem assembly into the receiver test facility and tighten the four captive screws.

5-21. Replacement of Electrical Frequency Synthesizer 245-800202-000 (fig. 5-14)

a. At the rear of the receiver test facility chassis, locate electrical frequency synthesizer 245800202-000 and electrical connector plate P1.

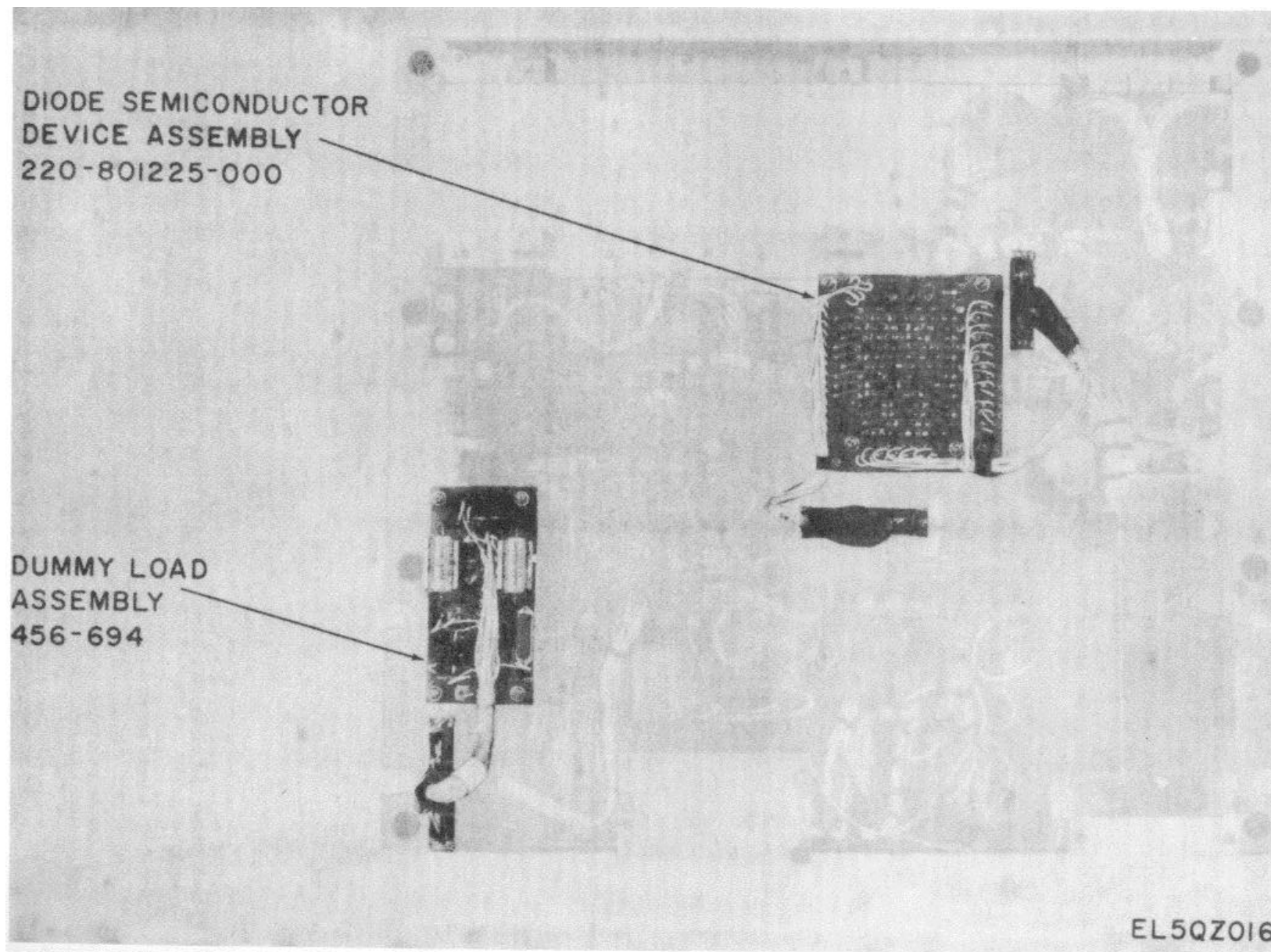

Figure 5-13. Receiver Test Facility Panel, Rear View

- b. Loosen the captive screw that secures the plate to the synthesizer and disconnect P1.
- c. Loosen the four captive screws and pull the synthesizer directly away from the chassis.
- d. Carefully position the replacement synthesizer, engage the chassis connector, and tighten the four captive screws.
- e. Connect P1 and J11 and tighten the captive screw to secure the plate to the synthesizer.

5-22. Replacement of Power Supply Subassembly 457-665 (fig. 5-14)

- a. At the rear of the receiver test facility chassis,

locate power supply subassembly 457-665.

- b. Loosen the two captive screws on P2 and disconnect P2 from J4.
- c. Loosen the seven captive screws that secure the subassembly to the chassis.
- d. Pull the subassembly directly away from the chassis.
- e. Carefully position the replacement power supply subassembly, engage the chassis connector, and tighten the seven captive screws.
- f. Connect P2 to J4 and tighten the two captive screws.

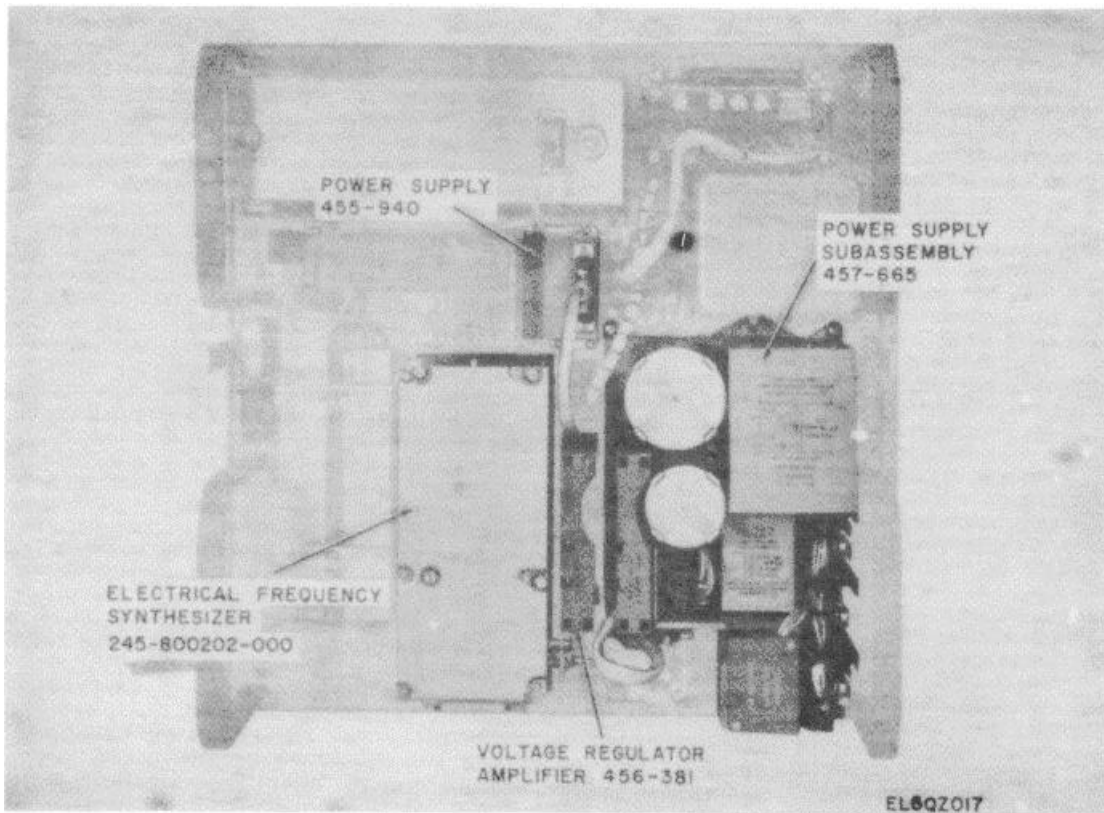

Figure 5-14. Receiver Test Facility Chassis, Rear View.

5-23. Replacement of Voltage Regulator Amplifier 456-381 (fig. 5-14)

- a. At the rear of the receiver test facility chassis, locate voltage regulator amplifier 456-381.
- b. Loosen the four captive screws that secure the assembly to the chassis.
- c. Pull the assembly directly away from the chassis.

- d. Carefully position the replacement voltage regulator amplifier, engage the chassis connector, and tighten the four captive screws.

5-24. Replacement of Power Supply 455-940 (fig. 5-14)

- a. At the rear of the receiver test facility chassis, locate power supply 455-940.

- b. Release the sliding lock on J8 and disconnect J8 from P1.
- c. Remove the four screws that secure the power supply to the chassis and remove the power supply.
- d. Position the replacement power supply and insert and tighten the four screws.
- e. Connect J8 and P1 and secure with the sliding lock.

- b. Locate amplifier-frequency multiplier 456-415 on the front of the receiver test facility chassis.
- c. Loosen the two captive screws and pull the assembly directly away from the chassis.
- d. Carefully position the replacement amplifier-frequency multiplier, engage the chassis connector, and tighten the two captive screws.
- e. Replace the front panel (para 5-9c).

5-25. Replacement of Amplifier-Frequency Multiplier 456-415 (fig. 5-15)

- a. Remove the receiver test facility front panel (para 5-9b).

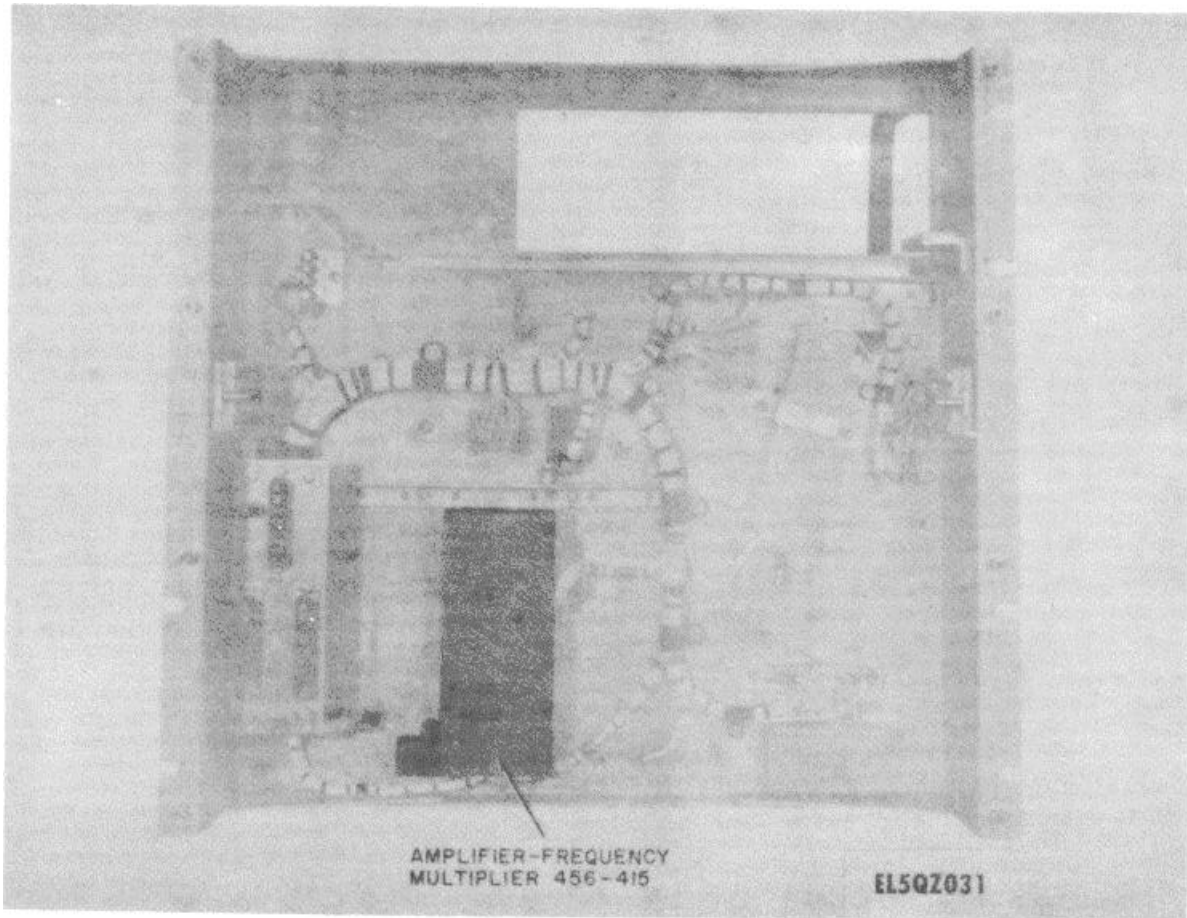

Figure 5-15. Receiver Test Facility Chassis, Front View.

5-26. Additional Troubleshooting Information*a. Transmitter Test Facility Interlock Check.***WARNING**

115 volts ac is present on the interlock switch terminals. Always disconnect the test facility ac power cord before working on the switches. Serious injury or death may result from contact with these terminals.

The interlocks consist of two pairs of switches operated by the POWER SUPPLY section hinged cover. Check the interlocks as follows:

(1) Set S1 to OFF and disconnect the ac power cord.

(2) Open the hinged cover, locate the interlock switches (fig. 3-1: S8, S9, S10, and S11), and check to see that they are secure. Adjust and tighten as necessary.

(3) Reconnect the ac power cord and set S1 to ON.

(4) Operate the interlock switches by simultaneously pressing the four switch rollers. Check to see that the +12 V and +28 V indicators light and that the fan runs.

(5) If the conditions in (4) above are not met, higher category of maintenance is required.

(6) Release the switches and close the hinged cover. The + 12 V and + 28 V indicators should light and the fan should run.

(7) If the +12 V and +28 V indicators do not light, readjust the position of S8 and S9 and repeat (6) above.

(8) If the + 12 V and +28 V indicators light and the fan does not run, readjust the position of S10 and S11 and repeat (6) above.

(9) If the conditions in (6) above are still not met, higher category of maintenance is required.

*b. Transmitter Test Facility Power Supply Replacement.***CAUTION**

Do not attempt to localize a power supply fault to a subassembly by substitution.

Replacement subassemblies may become damaged. Always replace all three subassemblies.

(1) The transmitter test facility power **supply** consists of three subassemblies: power supply subassembly 406-503, power supply subassembly 455-100, and voltage regulator amplifier 455-487.

(2) To replace the power supply, follow the sub-assembly replacement procedures given in paragraphs 5-14, 5-15, and 5-16.

c. Receiver Test Facility Power Supply Replacement.

(1) The receiver test facility power supply consists of two subassemblies: power supply subassembly 457-665 and voltage regulator amplifier 456-381.

(2) To replace the power supply, follow the subassembly replacement procedures given in paragraphs 5-22 and 5-23.

5-27. Replacement of Circuit Card Assembly No. 1 4A1A1 (fig. 5-16)

a. Remove RF modules test facility front panel from the case by loosening the eight captive screws, and carefully pulling the front panel directly away from the case. Lay the front panel face downward.

b. Loosen the two captive screws in the circuit card assembly No. 1 plug, and disconnect the plug.

c. Loosen the four screws that secure the circuit card assembly to the front panel, and remove the circuit card.

d. Align the four captive screws of the replacement circuit card assembly No. 1 with the mounting posts and tighten the screws.

e. Connect the circuit card assembly plug with its mating connector and tighten the two captive screws.

f. Replace the front panel in the case.

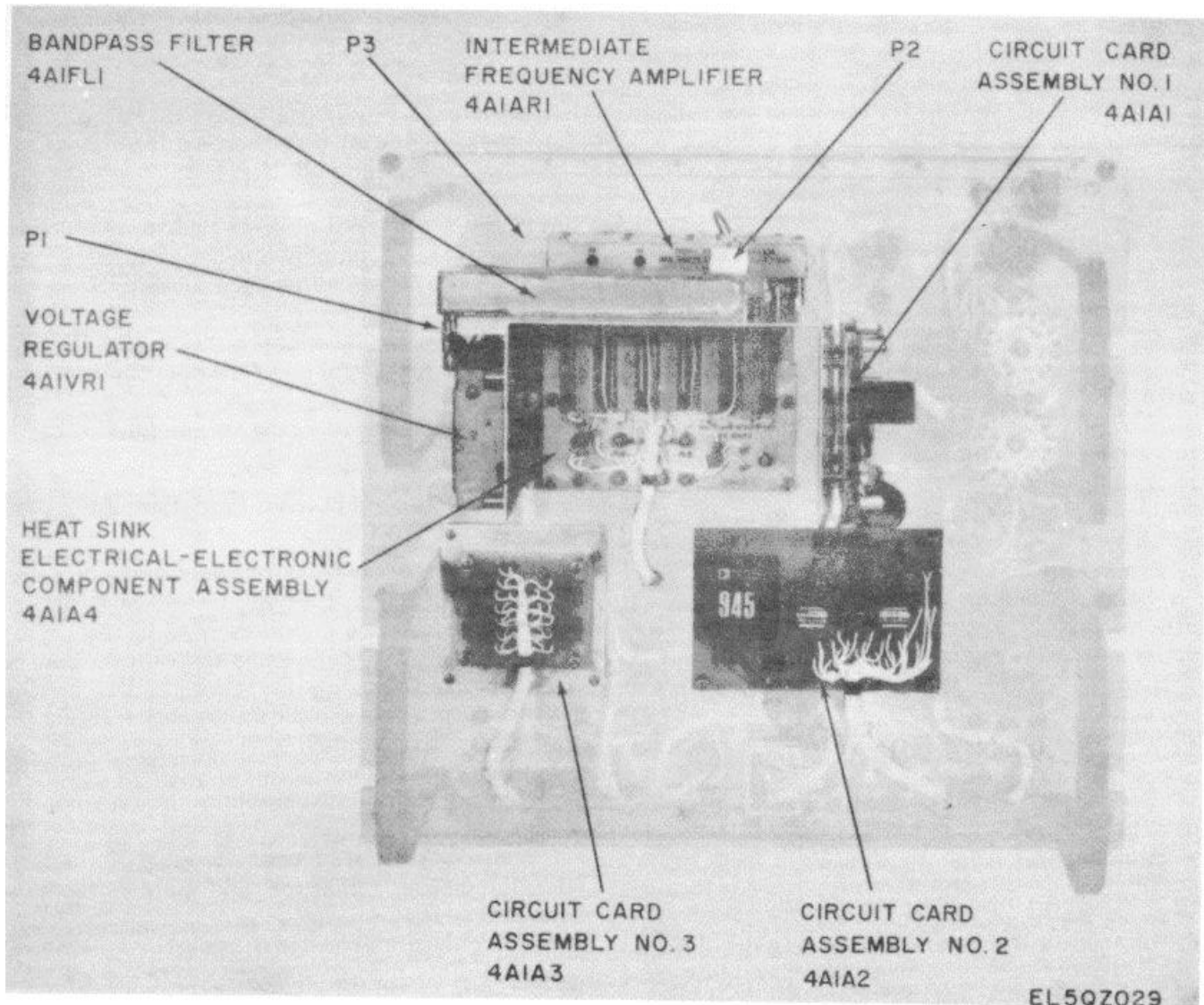

Figure 5-16. RF Modules Test Facility Front Panel, Rear View.

5-28. Replacement of Heat Sink, Electrical-Electronic Component Assembly 4A1A4 (fig. 5-16)

a. Remove the RF modules test facility front panel from the case, and lay the panel face downwards.

b. Loosen the two captive screws in the heat sink electrical-electronic component assembly (heat sink assembly) plug, and disconnect the plug.

c. Loosen the five captive screws that secure the heat sink assembly to the front panel and remove the heat sink assembly.

d. Aline the five captive screws of the replacement heat sink assembly with the mounting posts

and tighten the screws.

e. Connect the heat sink assembly plug with its mating connector and tighten the two captive screws.

f. Replace the front panel in the case. 5-29. Replacement of Voltage Regulator 4AIVR1 (fig. 5-16)

5-29. Replacement of Voltage Regulator 4A1VR1 (fig. 5-16)

a. Remove the RF modules test facility front panel from the case, and lay the panel face downwards.

b. Loosen the four captive screws that secure the voltage regulator to the front panel.

c. Pull the voltage regulator directly away from the front panel.

d. Carefully position the replacement voltage regulator and engage the front panel connector.

e. Tighten the four captive screws in the voltage regulator and replace the front panel in the case.

5-30. Replacement of Circuit Card Assembly No.2 4A12 (fig. 5-16)

a. move the RF modules test facility front panel from the case, and lay the panel face downwards.

b. Loosen the two captive screws in the circuit card assembly No. 2 plug, and disconnect the plug.

c. Loosen the four captive screws that secure the circuit card assembly to the front panel, and remove the circuit card assembly.

d. Aline the four captive screws of the replacement circuit card assembly No. 2 with the mounting posts and tighten the screws.

e. Connect the circuit card assembly No. 2 plug with its mating connector and tighten the two captive screws.

f. Replace the front panel in the case.

5-31. Replace of Bandpass Filter 4A1FL1 (fig. 5-16)

a. Remove RF modules test facility front panel from the case, and lay the panel face downwards.

b. Disconnect P1 and P2 (fig. 5-16) from band-pass filter J1 and J2 respectively.

c. Remove the two screws that secure the band-pass filter to the front panel, and remove the filter.

d. Position the replacement bandpass filter in place on the front panel and secure with the two screws removed in c above.

e. Reconnect P1 to J1 and P2 to J2.

f. Replace the front panel in the case.

5-32. Replacement of Intermediate Frequency Amplifier 4A1AR1 (fig. 5-16)

a. Remove RF modules test facility front panel from the case, and lay the panel face downwards.

b. Disconnect plug P3 (fig. 5-16) from the amplifier.

c. Loosen the three green-circled captive screws that secure the IF. amplifier, to the front panel.

d. Pull the IF. amplifier directly away from the front panel.

e. Carefully position the replacement IF. amplifier, engage the front panel chassis connector, and tighten the three captive screws.

f. Reconnect plug P3 to the IF. amplifier.

g. Replace the front panel in the case.

5-33. Replacement of Circuit Card Assembly No. 3 4A1A3

a. Remove RF modules test facility front panel from the case, and lay the panel face downwards.

b. Loosen the two captive screws in the circuit card assembly No. 3 plug, and disconnect the plug.

c. Loosen the four captive screws that secure the circuit card assembly to the front panel, and remove the circuit card assembly.

d. Aline the four captive screws of the replacement circuit card assembly No. 3 with the mounting posts and tighten the screw.

e. Connect the circuit card assembly No. 3 plug with its mating connector, and tighten the two captive screws.

f. Replace the front panel in

CHAPTER 6
SHIPMENT, LIMITED STORAGE, AND DEMOLITION TO PREVENT ENEMY USE

Section I. SHIPMENT AND LIMITED STORAGE

6-1. Disassembly of Equipment

Disassemble the test facilities set as follows:

- a. Perform the stopping procedure (para 3-38).
- b. Store all cables and accessories in their assigned places in the accessory kit and in the lids of the test facility cases (fig. 1-2, 1-4, and 1-10).
- c. If the test facilities set is rack-mounted, remove the units from the racks and mount them in their cases.
- d. Close the case lids and secure the latches.

6-2. Repackaging for Shipment or Limited Storage

Repackaging of equipment for shipment or limited storage normally will be performed at a packaging facility or by a repackaging team. Should emergency packaging be required, select the materials from those listed in SB 38-100. Package the equipment in accordance with the original packaging, so far as possible, with the available materials.

Section II. DEMOLITION TO PREVENT ENEMY USE

6-3. Authority for Demolition

Demolition of the equipment will be accomplished only upon order of the commander. Use the destruction procedure outlined in paragraph 6-4 to prevent further use of the equipment.

6-4. Methods of Destruction

Use any of the following methods to destroy the equipment:

- a. *Smash.* Smash the cases, the front and

rear panels, controls, switches, connectors, printed circuit boards, and the meters.

- b. *Cut.* Cut the harnesses and power, RF, and interconnecting cables.

- c. *Burn.* Burn cables and technical manuals.

- d. *Explode.* Use firearms, grenades or TNT, if necessary.

- e. *Dispose.* Bury or scatter the destroyed parts or throw them into streams.

**APPENDIX A
REFERENCES**

DA Pam 310-1	Consolidated Index of Army Publications and Blank Forms.
SB 38-100	Preservation, Packaging, Packing and Marking Materials, Supplies and Equipment Used by the Army.
TB 43-0118	Field Instructions for Painting and Preserving Electronics Command Equipment Including Camouflage Pattern Painting of Electrical Equipment Shelters.
TM 11-5820-540-12	Operator's and Organizational Maintenance Manual: Radio Sets, ANIGRC-103(V)1 (NSN 5820-00-935-4931), AN/GRC-103(V)2 (5820-00-116-6029), AN/GRC-103(V) 3 (5820-00-116-6030), AN/GRC-103(V)4 and Extension Kit, Mast, MK-1009/GRC-103(V) (5958-00-179-7767).
TM 11-5820-540-35	Direct Support, General Support, and Depot Maintenance Manual: Radio Sets AN/GRC-103(V)1 (NSN 5820-00-935-4931), AN/GRC-103(V)2 (5820-00-116-6029), AN/GRC-103(V)3(5820-00-116-6030), AN/GRC-103(V) 4 and Extension Kit, Mast, MK-1009/GRC-103(V) (5985-00-179-7767).
TM 11-5820-540-40-1	General Support Maintenance Manual Radio Sets AN/GRC-103(V)1 (NSN 5820-00-935-4931), AN/GRC-103(V)2 (NSN 5820-00-116-6029), AN/GRC-103(V)3 (NSN 5820-00-116-6030), AN/GRC-103(V)4 (NSN 5820-01-081-8866), and Extension Kit, Mast MK-1009/GRC-103(V) (NSN 5985-00-179-7767).
TM 11-5820-540-4-2	General Support Maintenance Manual Radio Sets AN/GRC-103(V)1 (NSN 5820-00-935-4931), AN/GRC-103(V)2 (NSN 5820-00-116-6029), AN/GRC-103(V)3 (NSN 5820-00-116-6030), AN/GRC-103(V)4 (NSN 5820-01-081-8866), and Extension Kit, Mast MK-1009/GRC-103(V) (NSN 5985-00-179-7767).
TM 11-5820-540-40-3	General Support Maintenance Manual Radio Sets AN/GRC-103(V)1 (NSN 00-935-4931), AN/GRC-103(V)2 (NSN 5800-00-116-6029), AN/GRC-103(V)3 (NSN 5820-00-116-6030), AN/GRC-103(V)4 (NSN 5820-01-081-8866), and Extension Kit, Mast MK-1009/GRC-103(V) (NSN 5985-00-179-7767).
TM 11-5820-540-34P-1	Direct Support and General Support Maintenance Repair Parts and Special Tools Lists (Including Depot Maintenance Repair Parts and Special Tools) for Radio Set AN/GRC-103(V)1 (NSN 5820-00-935-4931); Mast Extension Kit and Direct Support Cable Kit.
TM 11-5820-540-34P-2	Direct Support and General Support Maintenance Repair Parts and Special Tools Lists (Including Depot Maintenance Repair Parts and Special Tools) for Radio Set AN/GRC-103(V)2 (NSN 5820-00-116-6029).
TM 11-5820-540-34P-3	Direct Support and General Support Maintenance Repair Parts and Special Tools Lists (Including Depot Maintenance Repair Parts and Special Tools) for Radio Set AN/GRC-103(V)3 (NSN 5820-00-116-6030).
TM 38-750	The Army Maintenance Management System (TAMMS).
TM 750-244-2	Procedures for Destruction of Electronics Materiel to Prevent Enemy Use (Electronics Command).

**APPENDIX B
COMPONENTS OF END ITEM LIST**

Section I. INTRODUCTION

B-1. Scope

This appendix lists integral components of and basic items for the AN/CRM-95(V)2 to help you inventory items required for safe and efficient operation.

B-2. General

This Components of End Item List is divided into the following sections:

a. Section II. Integral Components of the End Item. These items, when assembled, comprise the AN/GRM-95(V)2 and must accompany it whenever it is transferred or turned in. The illustrations will help you identify these items.

b. Section III. Basic Issue Items. These are the minimum essential items required to place the AN/GRM-95(V)2 in operation, to operate it, and to perform emergency repairs. Although shipped separately packed they must accompany the AN/GRM-95(V)2 during operation and whenever it is transferred between accountable officers. The illustrations will assist you with hard-to-identify items. This manual is your authority to requisition replacement BII, based on TOE/MTOE authorization of the end item.

B-3. Explanation of Columns

a. Illustration. This column is divided as follows:

(1) *Figure number.* Indicates the figure number of the illustration on which the item is shown.

(2) *Item number.* The number used to identify item called out in the illustration.

b. National Stock Number. Indicates the National stock number assigned to the item and which will be used for requisitioning.

c. Part Number. Indicates the primary number used by the manufacturer, which controls the design and characteristics of the item by means of its engineering drawings, specifications, standards, and inspection requirements to identify an item or range of items. Following the part number, the Federal Supply Code for Manufacturers (FSCM) is shown in parentheses.

d. Description. Indicates the Federal item name and, if required, a minimum description to identify the item.

e. Location. The physical location of each item listed is given in this column. The lists are designed to inventory all items in one area of the major item before moving on to an adjacent area.

f. Usable on Code. Not applicable.

g. Quantity Required (Qty Reqd). This column lists the quantity of each item required for a complete major item.

h. Quantity. This column is left blank for use during an inventory. Under the Rcvd column, list the quantity you actually receive on your major item. The Date columns are for your use when you inventory the major item at a later date; such as for shipment to another site.

(Next printed page is B-3)

SECTION II. INTEGRAL COMPONENTS OF END ITEM

(1) ILLUS.		(2) NATIONAL STOCK NUMBER	(3) DESCRIPTION		(4) LOCATION	(5) USUABLE ON CODE	(6) QTY REQD	(7) QUANTITY	
(A) FIG.	(B) ITEM		PART NUMBER	CAGE				RCVD	DATE
1-1		6625-01-107-5033	TEST FACILITY SET AN/GRM-95(V)2 CONSISTING OF: TEST FACILITY, TRANSMITTER TS-2866(V) 2/GRM-95(V)2 245-801316-000 (90073)				1		
1-3		6625-01-104-8925	TEST FACILITY, RECEIVER TS-2867(YV) 2/GRM-95(V)2 245-800219-002 (90073)				1		
1-5		6625-01-108-3624	ACCESSORY KIT, TEST FACILITY NK-1173 (V)2/GRM-1 95(V)2 334-984-1 (90073)				1		
1-7		6625-01-105-8644	TEST FACILITY, RADIO FREQUENCY MODULES TS-3837(V)I/GRM-95(V)2 245-803020-000 90073)				1		
1-9		6625-01-105-0440	ACCESSORY KIT, TEST MK-1985(Y)1/GRI95(V)2 241-803022-000(90073)				1		
3-8		6625-01-105-8643	TEST FIXTURE, FREQUENCY MULTIPLIER TS-3824/GRN-95(V)2 617-800422-000 (90073)				1		
3-9		6625-01-108-4867	TEST FIXTURE, BAND PASS FILTER TS-3825(V)2/GRM-95(V)2 617-800418-000 (90073)				1		
3-10		6625-01-105-0442	TEST FIXTURE, AMPLIFIER-FREQUENCY MULTIPLIER TS-3826/GRM-9 (V)2 617-800423-000 (90073)			1			
3-10		6615-01-105-4187	TEST FIXTURE. BAND PASS FILTER TS-3827/GRM-95(V)2 617-800415-000(90073)				1		
3-12		6625-01-105-0445	TEST FIXTURE, RADIO FREQUENCY AMPLIFIER TS-3838/GRM-95(V)2 617-800424-000 (90073)				1		
3-13		6625-01-105-4191	TEST FIXTURE, FREQUENCY MULTIPLIER TS-3829/GI-956(V)2 617-800425-000 (90073)				1		
3-14		6625-01-105-4189	TEST FIXTURE PAND PASS FILTER TS-3830/GRI-9S(V)2 617-800413-000 (90073)				1		

SECTION III. BASIC ISSUE ITEMS

(1) ILLUS.		(2) NATIONAL STOCK NUMBER	(3) DESCRIPTION		(4) LOCATION	(5) USUABLE ON CODE	(6) QTY REQD	(7) QUANTITY	
(A) FIG.	(B) ITEM		PART NUMBER	CAGE				RCVD	DATE
			TECHNICAL MANUAL TM 11-6625-1696-12			1			

APPENDIX D MAINTENANCE ALLOCATION

Section I. INTRODUCTION

D-1. General

This appendix provides a summary of the maintenance operations for AN/GRM-95(V)2. It authorizes categories of maintenance for specific maintenance functions on repairable items and components and the tools and equipment required to perform each function. This appendix may be used as an aid in planning maintenance operations.

D-2. Maintenance Function

Maintenance functions will be limited to and defined as follows:

a. Inspect. To determine the serviceability of an item by comparing its physical, mechanical, and/or electrical characteristics with established standards through examination.

b. Test. To verify serviceability and to detect incipient failure by measuring the mechanical or electrical characteristics of an item and comparing those characteristics with prescribed standards.

c. Service. Operations required periodically to keep an item in proper operating condition, i.e., to clean (decontaminate), to preserve, to drain, to paint, or to replenish fuel, lubricants, hydraulic fluids, or compressed air supplies.

d. Adjust. To maintain, within prescribed limits, by bringing into proper or exact position, or by setting the operating characteristics to the specified parameters.

e. Align. To adjust specified variable elements of an item to bring about optimum or desired performance.

f. Calibrate. To determine and cause corrections to be made or to be adjusted on instruments or test measuring and diagnostic equipments used in precision measurement. Consists of comparisons of two instruments, one of which is a certified standard of known accuracy, to detect and adjust any discrepancy in the accuracy of the instrument being compared.

g. Install. The act of emplacing, seating, or fixing into position an item, part, module (component or assembly) in a manner to allow the proper functioning of the equipment or system.

h. Replace. The act of substituting a serviceable

like type part, subassembly, or module (component or assembly) for an unserviceable counterpart.

i. Repair. The application of maintenance services (inspect, test, service, adjust, align, calibrate, replace or other maintenance actions (welding, grinding, riveting, straightening, facing, remachining, or resurfacing) to restore serviceability to an item by correcting specific damage, fault, malfunction, or failure in a part, subassembly, module (component or assembly), end item, or system.

j. Overhaul That maintenance effort (service/action) necessary to restore an item to a completely serviceable/operational condition as prescribed by maintenance standards (i.e., DMWR) in appropriate technical publications. Overhaul is normally the highest degree of maintenance performed by the Army. Overhaul does not normally return an item to like new condition.

k. Rebuild Consists of those services/actions necessary for the restoration of unserviceable equipment to a like new condition in accordance with original manufacturing standards. Rebuild is the highest degree of materiel maintenance applied to Army equipment. The rebuild operation includes the act of returning to zero those age measurements (hours, miles, etc.) considered in classifying Army equipments/components.

D-3. Column Entries

a. Column 1, Group Number. Column 1 lists group numbers, the purpose of which is to identify components, assemblies, subassemblies, and modules with the next higher assembly.

b. Column 2, Component/Assembly. Column 2 contains the noun names of components, assemblies, subassemblies, and modules for which maintenance is authorized.

c. Column 3, Maintenance Functions. Column 3 lists the functions to be performed on the item listed in column 2. When items are listed without maintenance functions, it is solely for purpose of having the group numbers in the MAC and RPSTL coincide.

d. *Column 4, Maintenance Category.* Column 4 specifies, by the listing of a "work time" figure in the appropriate subcolumn(s), the lowest level of maintenance authorized to perform the function listed in column 3. This figure represents the active time required to perform that maintenance function at the indicated category of maintenance. If the number or complexity of the tasks within the listed maintenance function vary at different maintenance categories, appropriate "work time" figures will be shown for each category. The number of task-hours specified by the "work time" figure represents the average time required to restore an item (assembly, subassembly, component, module, end item or system to a serviceable condition under typical field conditions. This time includes preparation time, troubleshooting time, and quality assurance/quality control time in addition to the time required to perform the specific tasks identified for the maintenance functions authorized in the maintenance allocation chart. Subcolumns of column 4 are as follows:

- C-Operator/Crew
- O-Organizational
- F-Direct Support
- H-General Support
- L-Specialized Repair Activity
- D-Depot

NOTE

If the SRA in your geographical area does not have the capability for the "L" maintenance functions listed in the MAC, or if there is no SRA in your geographical area, utilize existing procedures for obtaining depot accomplishment of the "L" maintenance functions.

e. *Column 5, Tools and Equipment.* Column

specified by code, those common tool sets (not individual tools) and special tools, test, and support equipment required to perform the designated function.

f. *Column 6, Remarks.* Column 6 contains an alphabetic code which leads to the remark in section IV, Remarks, which is pertinent to the item opposite the particular code.

D-4. Tool and Test Equipment Requirements (Sect. III)

a. *Tool or Test Equipment Reference Code.* The numbers in this column coincide with the numbers used in the tools and equipment column of the MAC. The numbers indicate the applicable tool or test equipment for the maintenance functions.

b. *Maintenance Category.* The codes in this column indicate the maintenance category allocated the tool or test equipment.

c. *Nomenclature.* This column lists the noun name and nomenclature of the tools and test equipment required to perform the maintenance functions.

d. *National/NATO Stock Number.* This column lists the National/NATO stock number of the specific tool or test equipment.

e. *Tool Number.* This column lists the manufacturer's part number of the tool followed by the Federal Supply code for manufacturers (5-digit) in parentheses.

D-5. Remarks (Sect. IV)

a. *Reference Code.* This code refers to the appropriate item in section II, column 6.

b. *Remarks.* This column provides the required explanatory information necessary to clarify items appearing in section II.

**SECTION II. MAINTENANCE ALLOCATION CHART
FOR
TEST FACILITY SET AN/GRM-95(V)2**

(1) GROUP NUMBER	(2) COMPONENT ASSEMBLY	(3) MAINTENANCE FUNCTION	(4) MAINTENANCE LEVEL					(5) TOOLS AND TEST EQPT.	(6) REMARKS
			C	O	F	H	D		
00	TEST FACILITY SET AN/GRM-95(V)2	Inspect Inspect Test Test	0.5					63 1 1 thru 5, 11, 17, 20, 23, 24, 26 thru 34, 371, 43, 44, 45,50, 52 thru 60 64	A A B
		Service Calibrate Replace Repair Repair Repair Overhaul		0.5 0.2 0.5		2.0 24.0 2.0	5.0 840.0	64 63 61 thru 64 61 thru 64 1 thru 67	C F D E
01	TEST FACILITY, TRANSMITTER TS-2866(Y)2/ GRM-95(V)2 (245-801316-000) (1)	Inspect Inspect Test Test	0.2					1, 64 1, 64 1 thru 5, 12, 17, 20, 23, 24, 26 thru 31, 34, 36, 44, 45, 47, 49, 51 thru 55	A A B
		Service Calibrate Replace Repair Repair Repair Inspect Test		0.5 0.1 0.6		8.0 1.0	40.0	1, 64 64 63 61 thru 64 61 thru 64	C F D E
0101	PANEL, TEST, TRANSMITTER SB-4048/G6RM95(v)2 (622-800100-000) (1A1)	Inspect Test		0.1		2.0		5, 20, 24, 26 thru 29	A
		Adjust Replace Repair Repair Repair Inspect Test Adjust Replace Repair Repair Repair		0.1 1.0		3.0 2.0	2.5	64 62 61, 62, 63 61, 62, 63	
010101	PANEL, TEST ELECTRICAL SUBASSEMBLY (407-650-2) (1A1A1)	Inspect Test Adjust Replace Repair Repair Repair				0.1 0.25 0.2		62 62 61, 62, 63 61, 62, 63	
01010101	DISCRIMINATOR (220-801317) (1A1A1A1)	Test Test		0.1		1.0	2.0	61, 62, 63 61, 62, 63	
		Adjust Calibrate Replace Repair				0.5 1.0 0.25 1.0		64 63	F
01010102	TIME OELAY ASSEMBLY (457-533) (1A1AIA2)	Test Test Replace Repair		0.1		0.2		1 64	B
		Repair Test Replace Repair Repair		0.2		0.5 0.1 0.1 0.2		1, 63 1 64 1, 63	
010101020	CIRCUIT CARD ASSEMBLY TIME DELAY (457-660) (1A1AIA2A1)	Test Replace Repair Test Adjust Replace Repair				0.25 0.1 0.1 0.2		5 64	
01010103	CIRCUIT CARD ASSEMBLY NO. 1 (407-356) tIAIAIA3)	Test Adjust Replace Repair				0.25 0.1 0.1 0.2		5 64 5, 63	

**Section II. MAINTENANCE ALLOCATION CHART
FOR
TEST FACILITY SET AN/GRM-95(V)2**

(1) GROUP NUMBER	(2) COMPONENT ASSEMBLY	(3) MAINTENANCE FUNCTION	(4) MAINTENANCE LEVEL					(5) TOOLS AND TEST EQPT.	(6) REMARKS
			C	O	F	H	D		
00	TEST FACILITY SET AN/GRM-95(V)2	Inspect Inspect Test Test	0.5					63 1 1 thru 5, 11, 17, 20, 23, 24, 26 thru 34, 37, 43, 44, 45, 50, 52 thru 60 64	A A B
		Service Calibrate Replace Repair Repair2.0 Repair Overhaul		0.5 0.2 0.5		2.0 24.0		64 63 61 thru 64 61 thru 64 1 thru 67	C F D E
01	TEST FACILITY, TRANSMITTER TS-2866(V)2/ 61R-95(V)2 (245-801316-000) (1)	Inspect Inspect Test Test	0.2	0.6 1.0		3.0	5.0 840.0	1, 64 1, 64 1 thru 5, 12, 17, 20, 23, 24, 26 thru 31, 34, 36, 44, 45, 47, 49, 51 thru 55	A A B
		Service Calibrate Replace Repair Repair Repair Inspect Test		0.5 0.1 0.6		8.0 1.0	40.0	1, 64 64 63 61 thru 64 61 thru 64	C F D E
0101	PANEL, TEST, TRANSMITTER SB-4048/GRM-95(V)2 (622-800100-000) (1A1)	Inspect Test		0.1		2.0		5, 20, 24, 26 thru 29	A
		Adjust Replace Repair Repair Repair Inspect Test		0.1 1.0		3.0 2.0	2.5	64 62 61, 62, 63 61, 62, 63	
010101	PANEL, TEST ELECTRICAL SUBASSEMBLY (407-650-2) (1A1A1)	Inspect Test Adjust Replace Repair Repair Repair Inspect Test		0.25 0.5		0.1 0.2 0.2	2.0	5 62 62 61, 62, 63 61, 62, 63	
01010101	DISCRIMINATOR (220-801317) (1A1A1A1)	Test Test		0.1		1.0		1, 17, 23, 26 thru 29, 31	
		Adjust Calibrate Replace Repair Test Test Replace Repair Repair Test				0.5 1.0 0.25 1.0		64 63	F
01010102	TIME EULAY ASSEMBLY (457-533) (1A1A1A2)	Test Test Replace Repair Repair Test Test Replace Repair Repair Test		0.1 0.2		0.2 0.2		1 64 1, 63	B
0101010201	CIRCUIT CARD ASSEMBLY, TIME DELAY (457-660) (1A1A1A2A1)	Test Replace Repair Test Test Adjust Replace Repair				0.5 0.1 0.1 0.2 0.25		1 64 1, 63 5	
01010103	CIRCUIT CARD ASSEMBLY NO. 1 (407-356) IA1A1A3)	Adjust Replace Repair				0.1 0.1 0.2		64 5, 17, 63	

**Section II. MAINTENANCE ALLOCATION CHART
FOR
TEST FACILITY SET AN/GRM-95(V)2**

(1) GROUP NUMBER	(2) COMPONENT ASSEMBLY	(3) MAINTENANCE FUNCTION	(4) MAINTENANCE LEVEL					(5) TOOLS AND TEST EQPT.	(6) REMARKS
			C	O	F	H	D		
0101020204	FREQUENCY DIVIDER (SM-C-865032) (1A1A2A2A14)	Test Adjust Replace Repair				0.5 0.2 0.2 1.0		1.17 64 1, 17, 63	I
0101020205	DIGITAL ELECTRONIC DIVIDER-COUNTER (SM-C-865003) (1A1A2AZA15)	Test Replace Repair				0.3 0.2 0.8		1, 17 64 1, 17, 63	
0101020206	DIGITAL ELECTRONIC COUNTER (SM-C-865034) (1A1A2A2A16)	Test Replace Repair				1.0 0.2 1.8		1, 17 64 1, 17, 63	
0101020207	ELECTRICAL SYNCHRONIZER (220-800454) (SN-C-865035) (1A1A2A2A17)	Test Replace Repair				1.0 0.2 1.5		1.17 64 1, 17, 63	
0101020208	SIGNAL DATA CONVERTER-STORER (220-800455) (SM-C-865036) (1A1A2A2A8)	Test Adjust Replace Repair				0.2 0.1 0.2 0.9		5, 17 5 64 5, 17, 63	
0101020209	OSCILLATOR RADIO FREQUENCY (220-800456) (SM-C-865037) (1A1A2A2Y11)	Test Adjust Adjust Replace Repair				0.3 0.1 0.3 0.2 2.0		1, 17, 28 1, 17 1, 17 64 1.17, 28, 63	H
01010203	AMPLIFIER FREQUENCY MULTIPLIER (407-070) (SM-E-698216) (1A1A2A3)	Test Test Adjust Calibrate Replace Repair		0.3		1.0 1.0 3.0 1.0		1, 3, 17, 20, 28 64 1, 3, 17, 20, 28, 63	D F, G
0101020301	AMPLIFIER-FREQUENCY MULTIPLIER (455-547) (SN-D-698229) (1A1A2A3A1)	Replace Repair				0.2 0.5		64 63	
0101020302	LOW PASS FILTER (334-164) (S-C-698173) (1A1A2A3FL1)	Replace Repair				0.2 0.2		64 63	
01010204	POWER SUPPLY SUBASSEMBLY (406-503) (1A1A2M)	Test Test Adjust Replace Repair		0.5		0.7 0.2 0.5		1 1, 2.5, 17, 26 64 1.2, 5, 17, 26, 63	B
0101020401	POWER SUPPLY SUBASSEMBLY (SM-D-698224) (1A1A2A4A1)	Test Test Replace Repair		0.1		0.3 0.2 0.3		64 63	B, L L
0101020402	POWER SUPPLY SUBASSEMBLY (SM-C-698227) (1A1A2A4PSI)	Test Test Replace Repair		0.1 0.2		0.3 0.3		64 63	B, L
01010205	POWER SUPPLY SUBASSEMBLY (HEAT SINK) (455-100) (SM-D-698225) (IAIA2A5)	Test Test Replace Repair		0.1 0.2		0.3 0.3		1.2, 5, 23, 28 64	B
01010206	CONTROL, ALARM (SM-C-698215) (A11A2A6)	Test Test Adjust Replace Repair		0.1		0.3 0.2 0.1 0.2 0.4		1 5, 26 64 63	B E

**II. MAINTENANCE ALLOCATION CHART
FOR
TEST FACILITY SET AN/GRM-95(V)2**

(1) GROUP NUMBER	(2) COMPONENT ASSEMBLY	(3) MAINTENANCE FUNCTION	(4) MAINTENANCE LEVEL					(5) TOOLS AND TEST EQPT.	(6) REMARKS
			C	O	F	H	D		
010102060	CONTROL, ALARM (SM-C-698228) (1A1A2A6A1)	Test Replace Repair				0.2 0.2 1.4		1, 5, 26 64 1, 5, 26, 63	L
01010207	AMPLIFIER, VOLTAGE REGULATOR (SM-C-698229) (1AA2AR1)	Test Test Adjust Replace Repair		0.1 0.2 0.2		0.3 0.5		1, 26 64 1, 26, 63	B
010102070	AMPLIFIER, VOLTAGE REGULATOR (SM-C-698232) (1A1A2A6AR1)	Test Replace Repair				0.3 0.2 0.5		64 1, 26, 63	L
0102	POWER SUPPLY SUBASSEMBLY MX-8415/GRM-95(V) (457-968) (1A9)	Inspect Test Test Adjust Replace Repair		0.1 0.5 0.2			0.7 L 0.2	1, 2, 5, 28 64 1, 2, 5, 25, 28, 63	A B
010201	POWER SUPPLY SUBASSEMBLY (455-100) (SM-D-698225) (1A9A1)	Test Test Replace Repair		0.1 0.2			0.3 0.3	1, 2, 5, 28 64 1, 2.5, 28, 63	B
0103	CASE, TEST FACILITY TRANSMITTER CY-7799/GRM-95(V) (1MP1)	Inspect Service Replace Repair		0.1 0.2		L 0.2	0.7	64 64 63	A
0104	HOSE ASSEMBLY, AIR DUCT MX-8414/GRM-95(V) (457-941) (1IP2)	Inspect Test Replace Repair		0.1 0.1 0.1				1 64 1, 63	A B
02	TEST FACILITY, RECEIVER TS-2867(V)2/GRM-95(V)2 (2)	Inspect Inspect Test Test Service Calibrate	0.5	0.6 0.5 0.5		3.0 L 8.0 L		64 1.3, 5, 11, 17, 20, 24, 27 thru 31, 44, 45, 46, 50, 52 thru 55, 58, 59, 64 64	A A B F
0201	PANEL, TEST, RECEIVER SB-4049/GRM-95(V)2 (2A1)	Repair Repair Repair Replace Inspect Test Adjust Replace Repair Repair Repair		0.1 0.1 0.1 0.1 0.1 0.1 0.1 0.5		0.2 L 1.0 4.0 2.0 L 1.0 1.0 L		64 61, 62, 63 61, 62, 63 64 5, 20, 26 thru 29 64 62 64 63	A C D

**Section II. MAINTENANCE ALLOCATION CHART
FOR
TEST FACILITY SET AN/GRM-95(V)2**

(1) GROUP NUMBER	(2) COMPONENT ASSEMBLY	(3) MAINTENANCE FUNCTION	(4) MAINTENANCE LEVEL					(5) TOOLS AND TEST EQPT.	(6) REMARKS
			C	O	F	H	D		
020101	PANEL, TEST, ELECTRICAL, SUBASSEMBLY (407-653-2) (2AIAI)	Inspect				0.1 L		64	
		Test				0.2 L			B
		Adjust				0.2 L			
		Replace				0.25 L		64	
02010101	DUMMY LOAD, ASSEMBLY (456-694) (2A1AIAI)	Repair				1.0 L		64	D
		Repair					2.0	63	
		Test		0.1		0.4 L		1, 3, 5.30, 52, 53	B
		Test				0.1 L		64	
02010102	CIRCUIT CARD ASSEMBLY (456-842) (ZALIA2)	Replace					0.5	1, 3, 5, 30, 52, 53, 63	
		Repair							
02010103	PCM TEST UNIT (406-346) (A1A1A3)	Test				0.1 L			J
		Adjust				0.2 L			J
		Replace				0.1 L		64	
		Repair				0.5		1, 9, 10, 63	
02010104	DEN (407-188) (A1AA4)	Test				0.6 L		1, 17, 28, 29	
		Adjust				0.2 L		1	
		Replace				0.1 L		64	
		Repair					0.6	1, 17, 28, 29, 63	
0201010401	LIMITER-OISCRIMINATOR, ELECTRICAL FREQUENCY (457-824) (2AIAIA4A1)	Test		0.2		1.8 L		5, 17, 20, 26, 28, 29., 31	B
		Replace						64	
		Repair		0.1			2.5	5, 17, 20, 26, 28, 29, 31, 63	
0201010401	LIMITER-OISCRIMINATOR, ELECTRICAL FREQUENCY (457-824) (2AIAIA4A1)	Test				1.0 L		1, 5, 17, 26, 29, 31, 32	
		Align				0.7 L		1, 5, 17, 26, 29, 31, 32	
		Replace				0.25 L		64	
		Calibrate				8.0 L			F
0201010401	ELECTRICAL NOISE LIMITER (455-369) (2AIAIA4AIA2)	Repair				0.5		1, 5, 17, 26, 263 31, 32, 63	
		Repair							
0201010401	DISCRININATOR SUBASSEMBLY (455-367) (2AIAIA4AIA3)	Replace				0.3		64	
0201010401	ELECTRICAL NOISE LIMITER (455-369) (2AIAIA4AIA2)	Replace				0.5		1, 63	
0201010401	ELECTRICAL NOISE LIMITER (455-378) (2AIAI4LMAA2)	Replace				0.3		64	
0201010401	CAPACITOR ASSEMBLY (333-815) (ZAIAlAIA4)	Repair				0.6		1, 63	
0201010401	ELECTRICAL NOISE LIMITER (455-378) (2AIAI4LMAA2)	Replace				0.3		64	
0201010401	CAPACITOR ASSEMBLY (333-815) (ZAIAlAIA4)	Repair				0.6		1, 63	
0201010401	ELECTRICAL NOISE LIMITER (455-378) (2AIAI4LMAA2)	Replace				0.3		64	
0201010401	CAPACITOR ASSEMBLY (333-815) (ZAIAlAIA4)	Repair				0.5		1, 41, 63	

**Section II. MAINTENANCE ALLOCATION CHART
FOR
TEST FACILITY SET AN/GRM-95(V)2**

(1) GROUP NUMBER	(2) COMPONENT ASSEMBLY	(3) MAINTENANCE FUNCTION	(4) MAINTENANCE LEVEL					(5) TOOLS AND TEST EQPT.	(6) REMARKS
			C	O	F	H	D		
02010104014	VIDEO AMPLIFIER (455-368) (2A1A1A4A1A5)	Replace Calibrate				0.3 2.0		64	F
0201010402	CONTROL, ELECTRICAL FREQUENCY (457-520) (2A1A1A4A2)	Repair Test Adjust Replace Repair				0.8 0.5 0.7 0.5 0.9		1, 9, 10, 63 1, 17, 28, 56 17, 28 64 1, 17, 28, 56,	
0201010403	DETECTOR ASSEMBLY, VIDEO SIGAL (456-631) (2A1A1MA3)	Test Replace Repair				0.5 0.5 0.5		1, 26, 28, 29, 57 64 1, 26, 28, 29.	63
0201010404	OSCILLATOR, RADIO FREQUENCY (406-335) (2A1A1MY1)	Test Adjust Replace Repair				0.8 L 0.6 L 0.2 L 0.5 L		1, 20, 28, 31, 58 20 64 1, 20, 28, 31.	
0201010405	OSCILLATOR ASSEMBLY, AUDIO FREQUENCY (456-645) (2LA1A1A4Y2)	Test Adjust Replace Repair				0.8 L 0.6 L 0.2 L 0.5 L		1, 17, 28, 59 1, 17, 28 64 1, 17, 28, 59,	63
02010105	SEMICONDUCTOR DEVICE ASSEMBLY, DIODE (220-80122S) (2A1A1AS)	Test Test Replace Repair		0.1		0.5 L 0.9		1 64 1.63	
02010106	AMPLIFIER, RADIO FREQUENCY (455-659) (2A1A1AR1)	Test Adjust Replace Calibrate Repair		0.2		1.0 0.25 0.20 2.0 0.9		11, 17, 20, 24, 27, 50 11, 17, 20, 24, 27, 50 64 11, 17, 20, 24, 27, 50, 63	F
0201010601	AMPLIFIER, RADIO FREQUENCY (455-142) (2A1A1AR1AR1) 02010107AMPLIFIER, IF (245-800183) (2A1A1AR2)	Replace Repair Test Calibrate Replace Repair				0.2 0.5 0.4 2.0 0.2 0.5		64 1, 11, 20, 63 1.11, 20 64	
0201010701	IF AMPLIFIER (220-800279) (2A1A1AR2AR1)	Replace Repair				0.3 0.5		64 1, 11, 20, 63	F
02010108	FILTER ASSEMBLY (456-854) (2A1A1FL1)	Test Adjust Replace Repair				1.0 0.2 0.3 0.5		1, 26, 28, 29, 55 26, 28 64 1, 26, 28, 29, 55, 63	

**Section II. MAINTENANCE ALLOCATION CHART
FOR
TEST FACILITY SET AN/GRM-95(V)2**

(1) GROUP NUMBER	(2) COMPONENT ASSEMBLY	(3) MAINTENANCE FUNCTION	(4) MAINTENANCE LEVEL				(5) TOOLS AND TEST EQPT.	(6) REMARKS
			C	O	F	H		
02010109	OSCILLATOR, AUDIO FREQUENCY (456-624) (2A1A1Y1)	Test Adjust Replace Repair				0.3 0.2 0.3 0.8	1, 17, 28.44 17 64 1, 17, 28, 44, 63	
020102	CHASSIS, TEST, ELECTRICAL SUASSEMBLY (542-800057-002) (2A1A2)	Inspect Replace Repair Repair		0.1 0.1		1.0	64 63 63	A D
02010201	AMPLIFIER-FREQUENCY MULTIPLIER (456-415) (2A1A2A1)	Test Test Align Replace Repair		0.2 2.0 1.0 0.2		10.5	1, 17, 20, 24, 27 1, 17, 20, 24, 27 64 1, 17.20.24. 27, 63	A
0201020101	AMPLIFIER-FREQUENCY (456-414) (2A1A2A1A1)	Replace Repair				0.5 0.7	64 1, 17, 20, 24, 27, 63	
0201020102	FILTER, LOW PASS (334-164) (2A1A2A3FL1)	Replace Repair				0.2 0.2	64 1, 63	
02010202	CIRCUIT CARD ASSEMBLY (456-796) (2A1A2A1A2)	Test Adjust Replace Repair				0.2 L 0.21 L 0.264 L 0.5 L	1 1, 63	
02010203	SYNTHESIZER, ELECTRICAL FREQUENCY (245-800202) (2A1A2A3)	Inspect Test Test Replace Repair		0.1 0.1 0.2		1.0 L	20, 26, 27.28 64 20.26, 21.28, 63	
0201020301	MODULATOR-OSCILLATOR (222-800159) (2AU2A3A2)	Test Adjust Replace Repair				0.8 L 0.3 L 0.2 L 1.0 L	1, 5, 17, 20 5, 20 64 1, 5, 17, 20, 63	
0201020302	AMPLIFIER-1MOTOR (456-284) (2A1A2A3A3)	Test Adjust Calibrate Replace Repair				0.4 0.2 1.0 0.2 1.5	5, 7 64 5.7.63	F
0201020303	INTERCONNECTING BOX (245-800203) (2ALA2A3A11)	Test Replace Repair				1.0 L 1.2 L 0.8 L	5.17 64 5, 17, 63	
020102030301	INTERCONNECT BOX SUBASSY (220-800457) (2A1A2A3A11A11)	Replace Repair				0.2 0.5	64 5, 17, 63	
0201020304	FREQUENCY DIVIDER (220-800457) (2A1A2A3A14)	Test Adjust Replace Repair				0.5 L 0.2 L 0.2 L 0.5 L	1, 17 1, 17 64 1, 17, 63	

**Section II. MAINTENANCE ALLOCATION CHART
FOR
TEST FACILITY SET AN/GRM-95(V)2**

(1) GROUP NUMBER	(2) COMPONENT ASSEMBLY	(3) MAINTENANCE FUNCTION	(4) MAINTENANCE LEVEL					(5) TOOLS AND TEST EQPT.	(6) REMARKS
			C	O	F	H	D		
0201J20305	DIGITAL ELECTRONIC DIVIDER-COUNTER (220-800452) (2AIA2A3A15)	Test				0.3		1.17	
		Replace				L C.2		64	
0201020306	DIGITAL ELECTRONIC COUNTER (220-800453) (2AIA2A3A16)	Repair				0.8		1, 17, 63	
		Test				L 1.0		1, 17	
0201020307	ELECTRICAL SYNCHRONIZER (220-800454) (2A1A2A3A17)	Replace				L 0.2		64	
		Repair				L 1.8		1, 17, 63	
0201020307	ELECTRICAL SYNCHRONIZER (220-800454) (2A1A2A3A17)	Test				L 1.0		1, 17	
		Replace				L 0.2		64	
0201020308	SIGNAL DATA CONVEPTER-STORER (220-800455) (2AIA2A3A11)	Repair				L 1.5		1, 17, 63	
		Test				L 0.2		5, 17	
0201020309	OSCILLATOR, RADIO FREQUENCY (220-800456) (2AIA2A3Y11)	Adjust				L 0.1		5	
		Replace				L 0.2		64	
0201020309	OSCILLATOR, RADIO FREQUENCY (220-800456) (2AIA2A3Y11)	Repair				L 0.9		5, 17, 63	
		Test				L 0.3		1, 17, 28	
0201020401	LIMITER-DISCRIMIITOR, ELECTRICAL (455-972) (2AIA2A4)	Adjust				L 0.1		1, 17	
		Adjust				L 0.3		1, 17H	
0201020401	LIMITER-DISCRIMIITOR, ELECTRICAL (455-972) (2AIA2A4)	Replace				L 0.2		64	
		Repair				L 2.0		1, 17, 28, 63	
0201020402	ELECTRICAL NOISE LIMITER (455-369) (2A1A2A4A3)	Test				L 1.0		1, 5, 17, 26, 29, 31, 32	
		Align				L 0.7		1, 5, 17, 26, 29, 31, 32	
0201020401	DISCRIMINATOR SUBASSEMBLY (455-367) (2A1A2A4A1)	Replace				L 0.25		64	
		Repair				L 0.5		1, 17, 26, 29, 63	
0201020402	ELECTRICAL NOISE LIMITER (455-369) (2A1A2A4A3)	Replace				L 0.3		64	
		Repair				L 0.5		1, 63	
0201020403	ELECTRICAL NOISE LIMITER (455-378) (2A1A2A4A4)	Replace				L 0.3		64	
		Repair				L 0.5		1, 63	
0201020404	CAPACITOR SUBASSEMBLY (333-815) (2AIA2A4A5)	Replace				L 0.3		64	
		Repair				L 0.5		1, 41, 63	
0201020405	VIDEO AMPLIFIER (455-368) (2AIA2A4AR1)	Replace				L 0.3		64	
		Repair				L 0.8		1.9., 10, 63	
02010205	POWER SUPPLY SUBASSEMBLY (457-665) (2AIA2A5)	Test		0.5		L 0.8		3, 17, 52, 53	
		Test				L 0.2		64	
0201020501	POWER SUPPLY SUBASSEMBLY, HEAT SINK	Replace				L 1.5		3, 17, 52, 53, 63	
		Repair				L 0.5		1, 63	

**Section II. MAINTENANCE ALLOCATION CHART
FOR
TEST FACILITY SET AN/GRM-95(V)2**

(1) GROUP NUMBER	(2) COMPONENT ASSEMBLY	(3) MAINTENANCE FUNCTION	(4) MAINTENANCE LEVEL					(5) TOOLS AND TEST EQPT.	(6) REMARKS
			C	O	F	H	D		
02010206	AMPLIFIER, VIDEO (455-975) (2A1A2AR1)	Test				1.0		1, 17, 26, 29	
		Adjust				L 0.2		26, 29	
		Replace				L 0.2		64	
		Repair				L 3.5		1, 11, 26, 29, 63	
0201020601	VIDEO MONITOR CIRCUIT CARD ASSEMBLY (455-117) (2A1A2AR1A2)	Adjust				0.2		26, 29	
		Replace				L 0.25		64	
0201020602	VIDEO MONITOR ALARM CONTROL (455-989) (2A1A2AR1A3)	Repair				L 0.2		26, 29	
		Adjust				L 0.2		26, 29	
0201020603	VIDEO AMPLIFIER CIRCUIT CARD ASEOBLY (455-984) (2A1A2AR1AR1)	Replace				L 0.25		64	
		Repair				L 0.5		26, 29, 63	
0201020604	HIGH PASS FILTER (455-041) (2AA2AR1FL1)	Adjust				0.2		26, 29	
		Replace				0.25		64	
02010207	AMPLIFIER, IF (455-973) (2A1A2AR2)	Repair				0.5		26, 29, 63	
		Test				0.2		1, 17, 20	
0201020701	RF DETECTOR (455-366) (2A1A2AR2A1)	Replace				0.25		64	
		Repair				0.5		1, 17, 20, 63	
0201020702	IF AMPLIFIER (455-363) (2A1A2AR2AR1)	Replace				0.2		64	
		Repair				0.2		1, 17, 20, 63	
0201020703	IF AMPLIFIER (455-365) (2A1A2A2AR2)	Replace				0.2		64	
		Repair				0.2		1, 17, 20, 63	
0201020704	IF AMPLIFIER (455-370) (2A1A2AR2AR3)	Replace				0.2		64	
		Repair				0.2		1, 17, 20, 63	
0201020705	IF AMPLIFIER (455-371) (2A1A2AR2AR4)	Replace				0.2		64	
		Repair				0.2		1, 17, 20, 63	
0201020706	IF AMPLIFIER (455377) (2A1A2AR2AR5)	Replace				0.2		64	
		Repair				0.2		1, 17, 20, 63	
02010208	AMPLIFIER, VOLTAGE REGULATOR (456-381) (2A1A2AR3)	Test		0.1					B
		Adjust				0.25 0.2		1, 17 17	
0201020801	VOLTAGE REGULATOR (455-322) (2A1A2AR3AR1)	Repair		0.2				64	E
		Replace				0.2		64	
02010209	POWER SUPPLY (455-940) (2A1A2PS1)	Test		0.1				1, 17, 63	B
		Replace				0.2		17	
02010212	CABLE ASSY, SPECIAL PURPOSE (456-865) (2A1A2W1)	Repair				0.2		64	
		Replace		0.2				17, 63	
		Repair				0.5		64 63	

**Section II. MAINTENANCE ALLOCATION CHART
FOR
TEST FACILITY SET AN/GRM-95(V)2**

(1) GROUP NUMBER	(2) COMPONENT ASSEMBLY	(3) MAINTENANCE FUNCTION	(4) MAINTENANCE LEVEL					(5) TOOLS AND TEST EQPT.	(6) REMARKS
			C	O	F	H	D		
0201021201	CIRCUIT CARD ASSEMBLY (457-757) (2A1A2W1A1)	Replace				0.2		64	
02010213	NOTCH FILTER (2A1A2FL2)	Repair				0.5		1, 63	
		Replace		0.2				64	
0202	CASE, TEST FACILITY, RECEIVER CY-7800/GRM-95(V) (2MP1)	Repair				0.5		63	
		Inspect		0.1					A
		Service		0.2				64	
		Replace				0.2		64	
		Repair					0.7	63	
0203	COVER PLATE, ACCESS CW-1083/GR-95(V) (2MP2)	Inspect		0.1					A
		Service		0.2				64	
		Replace				0.2		64	
		Repair					0.5	63	
03	ACCESSORY KIT, TEST FACILITIES SET NK-1173(V)2/GRM-95(V) (334-984-1) (3)	Inspect		0.2					A
		Inspect				0.6		64	
		Test				2.0		1, 3, 17, 20, 23, 24, 26, 27, 28, 30, 37, 43, 45, 48, 52	
		Service		0.5				64	
		Replace		0.1				64	C
		Replace				0.3		64	
		Repair				0.5		64	E
		Repair				20.0		1, 3, 17, 20, 23, 24, 26, 27, 28, 30, 37, 43, 45, 48, 52, 63	
0301	TEST SET, CONTROL INDICATOR TS-3831/GRM-95 (245-803041-000) (3A1)	Inspect		0.1					A
		Test				0.3		52	
		Adjust				0.2		64	K
		Replace				0.1		64	
		Repair				1.5		52, 63	
030101	ROLLER ASSEMBLY, TAPE (406-386-1) (3A1A2)	Inspect		0.1					
		Test				0.2		64	
		Adjust				0.8		64	K
		Repair				1.0		63	
030102	CONTROL ASSEMBLY, INDICATOR 220-803041-000) (3A1A1)	Test				0.2		63	L
		Replace				0.2		64	
		Repair				0.5		63	L
030103	WIRING HARNESS, BRANCHED (217-803041-000) (3A1WI)	Test				0.2			L
		Replace				0.2		64	
		Repair				0.5		63	
		Inspect				0.1			A
0302	TEST STAND, FREQUENCY MULTIPLIER MX-8437A/GRM-95(V) (407-224-1) (3A2)	Test				0.1			
		Replace				0.1		64	
		Repair				0.5		63	
030201	ELECTRONIC SWITCH (245-800221-000) (3A2A1)	Test				1.5		23, 27, 31	
		Replace				0.4		64	
		Repair				0.5		23, 27, 37, 63	
03020101	ELECTRONIC SWITCH (220-800189-000) (3A2A1)	Test				0.5			L
		Replace				0.4		64	
		Repair				0.5		23, 27, 37, 63	
D303	TEST SET, INTERCONNECTING BOX TS-2870/GRM-95(V) (457-521) (3A3)	Inspect				0.1			A
		Test				0.5		1	
		Inspect		0.1					A
		Replace		0.1				64	
		Repair					0.5	63	

**Section II. MAINTENANCE ALLOCATION CHART
FOR
TEST FACILITY SET AN/GRM-95(V)2**

(1) GROUP NUMBER	(2) COMPONENT ASSEMBLY	(3) MAINTENANCE FUNCTION	(4) MAINTENANCE LEVEL					(5) TOOLS AND TEST EQPT.	(6) REMARKS
			C	O	F	H	D		
0304	CONVERTER, FREQUENCY, ELECTRONIC CV-2500/GR (456-550) (3A4)	Inspect Test				0.1 0.75		3, 117, 20, 24, 26, 21, 28, 38, 43, 45	
		Adjust Replace Repair				0.5 0.1 1.0		28 64 3, 17, 20, 24, 26, 27, 28, 38, 43, 45, 63	
030401	CONVERTER, FREQUENCY, ELECTRICAL (456-309) (3A4Y1)	Test Replace Repair				0.5 0.1 1.5		28 64 23, 63	
03040101	OSCILLATOR, RF (334-886) (3A4Y1Y1)	Test Replace Repair				0.2 0.2 1.0		3, 17, 20, 24, 26 thru 28, 38 64 3, 17, 20, 24, 26 thru 28, 38, 43, 45, 63	
0305	PRINTED WIRING BOARD PL-1251/GRM-95(V) (457-691) (3A5)	Inspect Test Replace Repair		0.1 0.2		0.1 0.2		64 63	A B
0306	PRINTED WIRING BOARD PL-1252/GRM-95(V) (457-692) (3A6)	Inspect Test Replace Repair		0.1 0.2		0.1 0.2		64 63	A B
U307	PRINTED WIRING BOARD PL-1253/G6R-95(V) (457-693)	Inspect Test Replace Repair		0.1 0.2		0.1 0.2		64 63	A B
0308	PRINTED WIRING BOARD PL-1254/GRM-95(V) (457-694) (3A8)	Inspect Test Replace Repair		0.1 0.2		0.1 0.2		64 63	A B
0309	PRINTED WIRING BOARD PL-1255/GRM-95(V) (457-695) (3A9)	Inspect Test Replace Repair		0.1 0.2		0.1 0.2		64 63	A B
0310	PRINTED WIRING BOARD PL-1256/GRM-95(V) (457-696) (3A10)	Inspect Test Replace Repair		0.1 0.2		0.1 0.2		64 63	A B
0311	PRINTED WIRING BOARD PL-1257/6GRM-95(V) (457-697) (3A11)	Inspect Test Replace Repair		0.1 0.2		0.1 0.2		64 63	A B
0312	PRINTED WIRING BOARD PL-1258/GRM-95(V) (457-698) (3A12)	Inspect Test Replace Repair		0.1 0.2		0.1 0.2		64 63	A B
0313	PRINTED WIRING BOARD PL-1259/GRM-95(Y) (457-699) (3A13)	Inspect Test Replace Repair		0.1 0.2		0.1 0.2		64 63	A B
0314	BRIDGE IMPEDANCE AND DUNMY LOAD, ELECTRICAL KIT MK-1174/U (192-408) (3A14)	Inspect Test Replace Repair		0.1 0.25 0.1		0.5		64 1, 63	A B

**Section II. MAINTENANCE ALLOCATION CHART
FOR
TEST FACILITY SET AN/GRM-95(V)2**

(1) GROUP NUMBER	(2) COMPONENT ASSEMBLY	(3) MAINTENANCE FUNCTION	(4) MAINTENANCE LEVEL					(5) TOOLS AND TEST EQPT.	(6) REMARKS
			C	O	F	H	D		
0315	DUMMY LOAD, ELECTRICAL OA-539/U (455-936) (3A30)	Inspect Test Replace Repair		0.1 0.25 0.1				64 63	A, M B
0316	PART KIT, ELECTRONIC EQUIPMENT (457-969) (3A31)	Inspect Repair		0.1 0.2		0.5		63	A
0317	PRINTED WIRING BOARD PL-1432/GRN-95(v) (220-800477-000) (3A33)	Inspect Test Replace Repair		0.1 0.1 0.2			0.1 0.2	64 63	A B
0318	PRINTED WIRING BOARD PL-1432/G6M95(V) (22-800477-000) (3A33)	Inspect Test Replace Repair		0.1 0.2			0.1 0.2	64 63	A B
0319	PRINTED WIRING BOARD PL-1433/GRM-95(V) (222-800478-000) (3A34)	Inspect Test Replace Repair		0.1 0.2			0.1 0.2	64 63	A B
0320	PRINTED WIRING BOARD PL-1434/GRM-95(V) (222-800479-000) (3A35)	Inspect Test Replace Repair		0.1 0.2			0.1 0.2	64 63	A B
0321	PRINTED WIRING BOARD PL-1435/G6R-95(V) (222-800408-000) (3A36)	Inspect Test Replace Repair		0.1 0.2			0.1 0.2	64 63	A B
0322	CASE, ACCESSORY KIT, TEST SET CY-7801/6GR-95(V) (407-703-1) (3MP1)	Inspect Service Replace Repair		0.1 0.2				64 64 63	A
0323	GAGE, DEPTH TL-766/6RG95(Y) (457-881-0) (3MP2)	Inspect Replace Repair		0.1 0.1			0.5	63	A
0324	GAGE, DEPTH TL-767/6RG-95(V) (457-881-1) (3MP3)	Inspect Replace Repair		0.1 0.1		0.5		63	A
0325	GAGE, DEPTH TL-768/Gm4-95(V) (457-881-2) (3MP4)	Inspect Replace Repair		0.1 0.1		0.5		63	A
0326	POWER SUPPLY PP-6304/GR4-95(V) (407-192) (3PS1)	Inspect Test Replace Repair		0.1 0.15 0.1			0.5	63	A B
04	TEST FACILITY, RADIO FREQUENCY NODULE TS-3837(V)2/6RG-95(V)2 (24-803020-000) (4)	Inspect Inspect Test Service Replace Replace Calibrate Repair Repair		0.2			0.6 2.0	64 1 thru 9, 11, 14, 16 thru 21, 66.67 64 64 64	A F D
				0.5 0.1			0.3 3.0 0.5	64 1 thru 9.11, 14, 16 thru 21, 63, 66.67	

**Section II. MAINTENANCE ALLOCATION CHART
FOR
TEST FACILITY SET AN/GRM-95(V)2**

(1) GROUP NUMBER	(2) COMPONENT ASSEMBLY	(3) MAINTENANCE FUNCTION	(4) MAINTENANCE LEVEL					(5) TOOLS AND TEST EQPT.	(6) REMARKS
			C	O	F	H	D		
0401	PANEL, TEST, ELECTRICAL TS-3832/GRM-95(V)2 (245-803021-000) (4A1)	Inspect Test		0.1		2.0		1, 3, 6 thru 9, 20, 21	A
		Replace			0.1			64	D
		Repair			0.4		2.0	1, 3, 6 thru 9, 20, 21, 63	
040101	CIRCUIT CARD ASSEMBLY NO.1 (220-803-016-000) (4A1A1)	Inspect Test		0.1		0.4		1, 3, 4, 5	A
		Replace		0.2		0.9		64	A
		Repair		0.1		0.75		1, 3, 4, 5, 18	
040102	CIRCUIT CARD ASSEMBLY NO. 2 (220-803017-000) (4A1A2)	Inspect Test		0.1		0.9		1, 3, 4, 5, 18, 63	A
		Replace		0.2		0.9		64	A
		Repair		0.1		0.35		1	
040103	CIRCUIT CARD ASSEMBLY NO. 3 (220-803018-000) (4A1A3)	Inspect Test		0.1		0.35		64	A
		Replace		0.2		0.5		63	
040104	HEAT SINK, ELECTRICAL-ELECTRONIC COMPONENT (245-803019-000) (4A1A4)	Inspect Test				0.1		1	64
		Replace				0.15		64	
		Repair				0.2	0.5	63	A
040105	AMPLIFIER, INTERMEDIATE FREQUENCY (245-406479-000) (4A1AR1)	Inspect Test				0.2		5, 7, 8, 9, 11, 14, 16, 1, .20, 66	
		Align				0.8	0.5	5, 7, 8, 9, 14, 16, 20, 66	L
		Replace				0.2	0.5	64	
04010501	AMPLIFIER-FILTER ASSEMBLY (4A1AR1A1)	Repair Test				0.8		63	L
		Replace				0.2		64	
04010502	AMPLIFIER, INTERMEDIATE FREQUENCY (220-800010-000) (4A1AR1AR1)	Repair Test				0.9		63	L
		Replace				0.8		64	
040106	REGULATOR, VOLTAGE (245-457899-001) (4A1VR1)	Repair Inspect Test		0.1		0.1		63	B
		Adjust					1.0	1, 3, 5	
		Replace		0.2			0.3	1, 3, 5	L
		Repair				1.0		64	
04010601	REGULATOR SUBASSEMBLY, VOLTAGE (220-800031-001) (4A1VRA11)	Test Replace				0.2		1, 3, 5, 63	L
		Repair				0.2		64	
0402	CASE, TEST FACILITY, RADIO FREQUENCY MODULE CY-7802/GRM-95() (538-800070-000) (4MP1)	Repair Inspect Service		0.1		1.5		63	A
		Replace		0.2		0.2		64	
		Repair					0.7	64	A
0403	SHIELD, FILTER ASSEMBLY NX-10127/U (617-800429-000) (4MP9)	Inspect Replace Repair		0.1		0.1		63	
						0.4		64	

**Section II. MAINTENANCE ALLOCATION CHART
FOR
TEST FACILITY SET AN/GRM-95(V)2**

(1) GROUP NUMBER	(2) COMPONENT ASSEMBLY	(3) MAINTENANCE FUNCTION	(4) MAINTENANCE LEVEL					(5) TOOLS AND TEST EQPT.	(6) REMARKS
			C	O	F	H	D		
05	ACCESSORY KIT TEST FACILITY SET W-1985(Y)/G6-g95(V) (5)	Inspect Inspect Test Service Replace Repair Repair		0.2			0.6 2.0	1 64 64 63 1, 63	A D
0501	PROBE. WAVEGUIDE TS-3836/G695(Y) (280-800150-001) (SCPZ6) (SCP27)	Inspect Test Replace Repair		0.1 0.1 0.1			40.0	64 63	
0502	CASE. ACCESSORY KIT, TEST FACILITY SET CY-7803/GR-95(Y) (5380071-000) (SMP1)	Inspect Service Replace Repair		0.1 0.2,			4 0.7	64 63	A
0503	SHORTIIG TOOL (53)	Inspect Replace Repair		0.1 0.1				63	A
0504	KNOB (610-800006-000) (5111)	Inspect Repair		0.1 0.2				64 64	A B
06	TEST FIXTURE, FREQUERICI MULTIPLIER TS-3824/r4-95(v)	Inspect Test Replace Repair Repair		0.1			0.2 0.1 1.0 5.0	64 64 63 64	A B
0601	DRIVE (MECHANIC (6MP2)								
07	CASE CY-7792/GAI95S(V) (6MP1)	Inspect Service Replace Repair		0.1 0.2				64 64 63	A
08	TEST FIXTURE. BAND PASS FILTER TS-3525/G51-95(V) (7)	Inspect Test Replace Repair		0.1				64 63	A
0801	DRIVE MECHANESM (7MP2)						5.0	64 63	
09	CASE CY-7793/GRW-95(V) (7MP1)	Inspect Service Replace Repair		0.1 0.2				64 64 63	A
10	TEST FIXTURE, A14PLIFIER-FREQUeICy TS-3826/0GK95(V) (8)	Inspect Test Replace Repair		0.1				64 63	A B
1001	SHAFT ASSEMBLY ADO DRIVE ECHANISM CASE CY-7794/G6R-95(V) (8MP1)	Inspect Service Replace Repair		0.1 0.2 0.1			5.0	64 64 63	A
11		Inspect Test Replace Repair		0.1 0.1 1.0				64 64 63	A B
12	TEST FIXTURE. BAND PASS FILTER TS-3827/GM6R-95() (9)	Inspect Test Replace Repair		0.1			0.2 0.1 5.0	64 63	A B
13	CASE CY-7795/GRN-95(V) (9MP1)	Inspect Service Replace Repair		0.1 0.2			0.1 1.0	64 64 63	A

**Section II. MAINTENANCE ALLOCATION CHART
FOR
TEST FACILITY SET AN/GRM-95(V)2**

(1) GROUP NUMBER	(2) COMPONENT ASSEMBLY	(3) MAINTENANCE FUNCTION	(4) MAINTENANCE LEVEL					(5) TOOLS AND TEST EQPT.	(6) REMARKS	
			C	O	F	H	D			
14	TEST FIXTURE, RADIO FREQUENCY AMPLIFIER TS-3828/GRM-95S(V) (10)	Inspect		0.1					A	
		Test				0.2			B	
		Replace				0.1				
15	CASE CY-7796/GRM-95(V) (10MP1)	Repair					5.0	64		
		Inspect		0.1				63	A	
		Service		0.2					64	
16	TEST FIXTURE, FREQUENCY MULTIPLIER TS-3829/GRM-95(V) (11)	Replace				0.1		64		
		Repair					1.0	63		
		Inspect		0.1						A
17	CASE CY-7797/GRM-95(V) (11MP1)	Test					0.2		A	
		Replace					0.1			
		Repair					5.0	64		
18	TEST FIXTURE BAND PASS FILTER TS-3830/GRM-95(V) (12)	Inspect		0.1					63	
		Test					0.2			A
		Replace					0.1		64	
19	CASE CY-7798/GRM-95(V) (12MP1)	Repair						5.0	63	
		Inspect		0.1						A
		Service		0.2					64	
		Replace				0.1		64		
		Repair					1.0	63		

**SECTION III. TOOL AND TEST EQUIPMENT REQUIREMENTS
FOR
TEST FACILITY SET AN/GRM-95(V)**

(1) TOOL OR TEST EQUIPMENT REF CODE	(2) MAINTENANCE LEVEL	(3) NOMENCLATURE	(4) NATIONAL/NATO STOCK NUMBER	(5) TOOL NUMBER
1	O, L, D	MULTIMETER, TS-352B/U	6625-00-553-0142	
2	L, D	INSULATION TESTER, AN/GSN-6	6625-00-542-1331	
3	L, D	POWER SUPPLY, LAMBDA LK 342 FM		
4	L, D	POWER SUPPLY, LAMBDA LH 124 FM		
5	L, D	VOLTMETER, DIGITAL AN/GSH-64	6625-00-870-2264	
6	L, D	GENERATOR, SIGNAL SG-1112(V)1/U	6625-00-566-3067	
7	L, D	POUER METER, HP-435A		
8	L, D	THERMISTOR MDUNT, HP-8484A		
9	L, D	COUNTER, ELECTRONIC, DIGITAL CP-772A/U	6625-00-973-4837	
10	L, D	CONVERTER, FREQUENCY, ELECT RONIC, PLUG-IN, CV-2DO38 (HP-5254B)	6625-00-941-8474	
11	L, D	GENERATOR, NOISE, LOW FREQUENCY,	SG-419/U	6625-00-853-3866
12	L, D	TEST FACILITIES SET AN/G6R-95(V)1		
13	L, D	UNIT AMPLIFIER, IF GENERAL RADID MODEL 1236	6625-00-179-9148	
14	L, D	GENERATOR, SWEEP FREQUENCY, WILTRON MODEL 6100		
15	L, D	FREQUENCY UNIT, PLUG-IN, (1GHZ-2 GHZ), WILTRON MODEL 6110-C		
16	L, D	FREQUENCY UNIT, PLUG-IN WILTRON 610840		
17	L, D	OSCILLOSCOPE. AN/US-281C	6625-00-106-9622	
18	L, D	RESISTOR, 110 OHMS ±1% 3 WATTS (CMC 288-990012-082)		
19	L, D	TEST SET, C-R-L, AN/URN-90	6625-00-534-7458	
20	L, D	POWER METER, ME-441/U	6625-00-436-4883	
21	L, D	THERMISTOR MOUNT, HP-478A		
22	L, D	GENERATOR, SIGNAL AN/U4S-213	6625-00-872-3215	
23	L, D	INDICATOR, USWR, AN/USK261/U	6625-00-935-1473	
24	L, D	GENERATOR, SWEEP SG-888/U	6625-00-133-7526	
25	L, D	WATTMETER, NE-441/U	6625-00-436-4883	
26	L, O	VOLTMETER, 1E-30A/U	6625-00-643-1670	
27	L, D	SIGNAL GENERATOR, AN/USH-44C	6625-00-138-7773	
28	L, D	COUNTER, ELECTRONIC DIGITAL READ- OUT, AN/USI-207A	6625-00-044-3228	
29	L, D	GENERATOR, SIGNAL AN/US, ZO5A	6625-01-007-4796	
30	L, D	BRIDGE. UNIVERSAL ZM1-71/U	6625-00-236-1536	
31	L, D	METER, ODUOWLATION ME-57A/U	6625-00-432-7312	
32	L, D	METER, DISTORTION VY4-B3 (WANDEL AND GOLTERMAN)		
33	L, D	OHNMETER, 2N-218/U	6625-00-172-6521	
34	L, D	STROBOSCOPE, TS-8OSB/U	6625-00-752-7992	
35	L, D	INDICATOR, SWR AN/USM-261	6625-00-935-1473	
36	L, D	MULTIMETER, AN/USN-34 W/11042 A PROBE	6625-00-498-3967	
37	L, D	DRIVE GENERATOR, SG-867/U	6625-00-498-3967	
38	L, D	WATTMETER, AN/URHI-120	6625-00-813-8430	
39	L, D	INDICATOR, DISTORTION AN/URM-180	6625-00-089-4227	
40	L, D	VOLTMETER, DIFFERENTIAL ME-202/U	6625-00-709-0288	

**SECTION III. TOOL AND TEST EQUIPMENT REQUIREMENTS
FOR
TEST FACILITY SET AN/GRM-95(V)**

(1) TOOL OR TEST EQUIPMENT REF CODE	(2) MAINTENANCE LEVEL	(3) NOMENCLATURE	(4) NATIONAL/NATO STOCK NUMBER	(5) TOOL NUMBER
41	L, D	BRIDGE. RESISTANCE. ZM-4/U	6625-00-166-0398	
42	L, D	GENERATOR. SWEEP SIGNAL, SG-5038/ URN (P/O AN/URM-503)		
43	L, D	RADIO SET AN/GRC-103(V)		
44	L, D	HP PROBE, 111 (HP-10003A)		
45	L, D	CLIP LEAD (TEKTRONIC 013-0076-00)		
46	L, D	FILTER BOX (PEN-SY-007)		
47	L, D	HP PROBE CONNECTOR (HP-11042)		
48	L, D	DUMMY LOAD (T-49756)		
49	L, D	HP DIVIDER PROBE (HP-1004)		
50	L, D	AMPLIFIER, RF (455-659)		
51	L, D	SYNTHESIZER, ELECTRICAL FRE- QUENCY (407-054)		
52	L, D	LEAD, TEST (PEN-SK-001)		
53	L, D	LEAD, TEST (PEN-SK-002)		
54	L, D	LEAD, TEST (PEN-SK-003)		
55	L, D	LEAD, TEST (PEN-SK-004)		
56	L, D	EXTENDER BOARD (220-800063)		
57	L, D	EXTENDER BOARD (220-800064)		
58	L, D	EXTENDER BOARD (220-800065)		
59	L, D	EXTENDER BOARD (220-800066)		
60	D	OVEN, TEMPERATURE-CONTROLLED, DELTA DESIGN 654SR		
61	L, D	TOOL KIT, ELECTRONIC EQUIPMENT TK-100G	5180-00-605-0079	
62	L, D	TOOL KIT, ELECTRONIC EQUIPMENT TK-101G	5180- 00-064-5178	
63	L, D	TOOL KIT, ELECTRONIC EQUIPMENT TK-105G	5180 -00-610-8177	
64	O, L	TOOL KIT, ELECTRONIC EQUIPMENT TK-115G	5180-00-856-1578	
65	D	DEPOT FACILITIES		
66	L, D	VSWR BRIDGE, ANZAC RB-3-50		
67	L, D	DIRECTIONAL COUPLER, ANZAC CH-132		
D-19				

SECTION IV. REMARKS FOR RADIO SET AN/GRC-240

REFERENCE CODE	REMARKS
A	VISUAL, EXTERNAL ONLY.
B	MAINTENANCE AND OPERATIONAL CHECKS ONLY.
C	FUSES, LAMPS, AND KNOBS.
D	REPAIR BY SUBASSEMBLY, REPLACEMENT ONLY.
E	REPAIR BY CIRCUIT CARD ASSEMBLY, REPLACEMENT ONLY.
F	REFER TO TB 11-6625-1696-35/1 FOR CALIBRATION PROCEDURES.
G	TESTED BY CALIBRATING THE METERING AND AMPLIFIER FREQUENCY MULTIPLIER AGC CIRCUITS.
H	THERMAL ADJUSTMENTS.
I	THERMAL ADJUSTMENTS AFTER REPAIRS.REFER TO TM 11-6625-1696-50/1.
J	TESTED AND ADJUSTED IN CONJUNCTION WITH RF TUNER, RADIO RECEIVER, SYNTHESIZER FREQUENCY AND VIDEO AMPLIFIER ASSEMBLIES.
K	MECHANICAL ADJUSTMENT.
L	TEST AS PART OF NEXT HIGHER ASSEMBLY.
M	PASSIVE TEST EQUIPMENT, PART OF TEST FACILITY SET.

INDEX

<i>Subject</i>	<i>Paragraph</i>
Accessories stored in RF modules test facility case.....	1-7
Accessory kit, test MK-1985(V)/GRM-95(V)2 components.....	1-8
Additional troubleshooting information.....	5-26
Administrative storage.....	1-4
AIR OUTLET section connector	3-10
Amplifier-frequency multiplier, replacement of	
407-070	5-13
456-415	5-25
Amplifier-frequency multiplier section controls, and connectors	3-15
Amplifier-frequency multiplier section controls, indicators, and connectors.....	3-7, 3-48, 3-49
Amplifier-frequency multiplier, test fixture TS-3826/GRM-95(V)2	3-54
AMPLIFIER, IF AMPL FREQ MULT section controls, and connectors	3-27
AMPLIFIER, IF section controls, indicators, and connectors.....	3-47
Amplifier, intermediate frequency, 4AIAR1, replacement of.....	5-32
AMPLIFIER-MONITOR section controls, and connectors	3-14
Amplifier, radio frequency section controls, indicators, and connectors.....	3-43, 3-45
Amplifier, radio frequency, test fixture TS-38281GRM-95(V)2	3-56
AMPLIFIER VIDEO section controls, indicators, and connectors	3-30
Amplifier, voltage regulator, replacement of	
455-487	5-16
456-381	5-23
Authority for distribution	6-3
Bandpass, filter, 4A1FL1, replacement of.....	5-31
Bandpass, filter, section connectors	3-44
Bandpass, filter, test fixture	
TS-38301GRM-95(V)2	3-58
TS-3827/GRM-95(V)2.....	3-55
TS-3825(V)/GRM-95(V)2	3-53
Centrifugal fan, replacement of	5-17
Circuit card assembly, replacement of	
No. 1, 4A1A1	5-27
No. 2, 4A1A2	5-30
No. 3, 4A1A3	5-33
Cleaning.....	4-5
Common names.....	1-12
Connectors, distribution section.....	3-46
Consolidated index of Army publications and blank forms	1-2
Control and connector, fan section	3-9
Controls, and connectors	
amplifier-frequency multiplier section	3-15
AMPLIFIER, IF AMPL FREQ MULT section.....	3-27
RADIO RCVR section	3-26
RF AMPLIFIER-MIXER CONVERTER ASSY section	3-23
RESTORER PULSE FORM section.....	3-28
Transmitter, radio section.....	3-11
30 MHz	3-21
Control and indicators	
METERING section.....	3-4, 3-19
POWER section.....	3-2, 3-20

	<i>Paragraph</i>
SYNTHESIZER, FREQUENCY HMz section	3-25
Controls, indicators, and connectors	
Amplifier-frequency multiplier section	3-7, 3-48, 3-49
AMPLIFIER IF section	3-47
AMPLIFIER RADIO FREQUENCY section.....	3-43, 3-45
AMPLIFIER VIDEO section.....	3-30
CONTROL ALARM section	3-12
CONT MON TEMP SENSOR section	3-17
CONV FREQ ELECTRONIC section.....	3-42
ELECTRONIC SWITCH section.....	3-13, 3-29
FREQUENCY MULTIPLIER section.....	3-50
ORDER WIRE section	3-16
POWER SUPPLY section.....	3-6, 3-22
Power Supply PP-6304/GRM-95(V)2	3-32
REGULATOR VOLTAGE section.....	3-41
SYNTHESIZER section.....	3-8
Test set control-indicator.....	3-33
TUNER RADIO FREQ section	3-24
26V SUPPLY section	3-3
Daily preventative maintenance checks and services chart, operator's.....	4-4
Delay assembly, time, replacement of.....	5-11
Demolition, authority for	6-3
Description of Test Facilities Set AN/GRM-95(V)2.....	1-12
Destruction, methods of	6-4
Destruction of Army electronics materiel	1-5
Disassembly of equipment	6-1
DISTRIBUTION section connectors.....	3-46
Dummy load assembly, replacement of.....	5-19
Electrical-electronic component assembly 4A1A4, Replacement of heat sink.....	5-28
Electrical frequency synthesizer, replacement,	
245-800202-000, receiver	5-21
245-800202-000, transmitter	5-12
ELECTRONIC CONV FREQ section controls, indicators, and connectors	3-42
ELECTRONIC SWITCH section controls, indicators, and connectors	3-13, 3-29
Equipment	
Checking unpacked.....	2-2
Disassembly of	6-1
Required, tools and test	5-2
Service upon receipt	2-1
Fan, Centrifugal, 333-139, replacement of	5-17
FAN section control and connector.....	3-9
Filter, Bandpass, 4A1FL1, replacement of.....	5-31
FILTER BANDPASS, section connectors	3-44
Filter, Bandpass, Test Fixture	
TS-3830/GRM-95(V)2	3-58
TS-3827/GRM-95(V)2	3-55
TS-3825(V)/GRM-95(V)2	3-53
Forms, Records and Reports, Maintenance.....	1-3
Frequency multiplier, amplifier, section controls, and connectors	3-15
Frequency multiplier, amplifier, section controls, indicators, and connectors	3-7, 3-48, 3-49, 3-50
Frequency multiplier, amplifier, IF amp section controls and connectors	3-27

	<i>Paragraph</i>
Frequency multiplier, amplifier, replacement of	
407-070	5-13
456-415	5-25
Frequency multiplier, amplifier, test fixture	
TS-3824/GRM-95(V)2	3-52
TS-3826/GRM-95(V)2	3-54
TS-3829/GRM-95(V)2	3-57
Frequency Multiplier, Test Stand, 407-22411, controls, indicators, and connectors.....	3-34
General.....	3-1, 3-
18,	
	3-31, 3-40,
	3-51
General replacement procedures	5-9
Heat sink, electrical-electronic component assembly, 4A1A4, replacement of;	5-28
Indicator and connectors, 30 MHz discriminator	3-5
Indicators, connectors, and controls,	
Amplifier, frequency multiplier section.....	3-7, 3-48,
	3-49
AMPLIFIER, IF section	3-47
Amplifier, radio frequency section	3-43, 3-45
CONTROL ALARM section	3-12
CONV FREQ ELECTRONIC section.....	3-42
FREQUENCY MULTIPLIER section.....	3-50
Interconnecting Box, Test Set TS-2870/GRM-95(V)2	3-35
Instructions	
Installation	2-3
Touchup painting	5-7
Kit, Accessory, Test Components	
MK-1985(V)I/GRM-95(V)2.....	1-8
Limited storage, or replacement for shipment.....	6-2
Maintenance Forms, Records, and Reports.....	1-3
METERING section control and indicator	3-4, 3-19
Methods of destruction	6-4
Modem 407-188, replacement of.....	5-20
Names, common.....	1-11
Operational procedures.....	3-36
Operator's maintenance, Scope of	4-1
Operator's preventative maintenance.....	4-2
Checks and Services	4-3
Daily	4-4
ORDER WIRE section controls, indicators, and connectors.....	3-16
Organizational maintenance, Scope of.....	5-1
Organizational preventative maintenance	5-3
Checks and services periods.....	5-4
Monthly.....	5-5
Quarterly	5-6
Organizational troubleshooting char	5-8
Outlet, air section connector.....	3-10
Painting, touchup instructions.....	5-7
POWER Section Control and Indicators	3-2, 3-20

	<i>Paragraph</i>
POWER SUPPLY section controls, indicators and connectors	3-6, 3-22
Power Supply, PP-6304/GRM-95(V)2, controls, indicators, fuses, and connectors.....	3-32
Preliminary starting procedure.....	3-37
Preventative maintenance, organizational.....	5-3
Checks and services chart	
Monthly.....	5-5
Quarterly	5-6
Checks and services periods.....	5-4
Preventative maintenance, operator's	4-2
Checks and services.....	4-3
Daily chart	4-4
Procedures, operational	3-36
Starting.....	3-38
Stopping	3-39
Purpose and Use.....	1-9
RF AMPLIFIER-MIXER CONVERTER ASSY section controls, and connectors.....	3-23
Radio frequency amplifier section controls, indicators, and connectors.....	3-43, 3-45
Radio frequency amplifier, test fixture TS-3828/GRM-95(V)2.....	3-56
Radio Frequency Modules Test Facility Case, Accessories, Stored in	1-7
Radio receiver section controls and connectors.....	3-26
Radio transmitter section controls and connectors.....	3-11
Records and Reports, Maintenance Forms.....	1-3
REGULATOR VOLTAGE section controls, indicators, and connectors	3-41
Repackaging for shipment or limited storage.....	6-2
Replacements	4-6
Replacements of	
Amplifier-frequency multiplier	
407-070	5-13
456-415	5-25
Bandpass Filter 4A1FL1.....	5-31
Centrifugal Fan 333-139	5-17
Circuit card assembly	
No.1, 4A1A.....	5-27
No. 2, 4A1A2.....	5-30
No. 3, 4A1A3.....	5-33
Dummy Load Assembly 456-694.....	5-19
Electrical Frequency Synthesizer 245-800202-00.....	5-12, 5-21
Heat Sink, Electrical-Electronic Component Assembly 4A1A4.....	5-28
Intermediate Frequency Amplifier 4A1AR1.....	5-32
Modem 407-188.....	5-20
Power Supply 455-940	5-24
Subassembly	
406-503	5-14
455-100	5-15
457-665	5-22
Procedures, General	5-9
Semi-conductor.....	5-10
Semi-conductor Device Assembly Diode 220-801-225-000	5-18
Time Delay Assembly 457-533.....	5-11
Voltage Regulator 4A1VR1	5-29
Amplifier	
455-487	5-16
456-381	5-23
Reporting equipment improvement recommendations (EIR)	1-6
RESTORER PULSE FORM section controls, and connectors	3-28

	<i>Paragraph</i>
Scope	1-1
Scope of maintenance	
Organizational	5-1
Operator's	4-1
Semiconductor, replacement of	5-10
Semiconductor device assembly diode 220-801225-000, replacement of	5-18
Service upon receipt of equipment	2-1
Starting procedure	3-38
Stopping procedure	3-39
Supply, 26V section control, indicator, fuses, and connectors	3-3
Supply, power, replacement of 455-940	5-24
Subassembly	
406-503	5-14
455-100	5-15
457-665	5-22
Switch, Electronic Section Controls, Indicators, and Connectors	3-13, 3-29
Synthesizer, electrical, frequency, replacement 245-800202-000	5-12, 5-21
SYNTHESIZER, FREQUENCY MHz section control, and indicator	3-25
SYNTHESIZER section controls, indicators, and connectors	3-8
Technical characteristics	1-10
TEMP SENSOR, CONT MON, section controls, indicators, and connectors	3-17
Test Facilities Set, AN/GRM-95(V)2, Description	1-12
Test Facility Case, RF Modules, Accessories Stored in	1-7
Test fixture, amplifier frequency multiplier TS-3826/GRM-95(V)2	3-54
Test fixture, bandpass filter	
TS-3830/GRM-95(V)2	3-58
TS-3827/GRM-95(V)2	3-55
TS-3825(V)/GRM-95(V)2	3-53
Test fixture, frequency multiplier	
TS-3824/GRM-95(V)2	3-52
TS-3829/GRM-95(V)2	3-57
Test fixture, radio frequency amplifier TS-3828/GRM-95(V)2	8-56
Test set control-indicator, controls, indicators, and connectors	3-33
Test Set, Interconnecting Box TS-2870/GRM-95(V)2, controls, indicators, and connectors	3-35
Test Stand, Frequency Multiplier 407-224/1, controls, indicators, and connectors	3-34
Time delay assembly 457-533, replacement of	5-11
Tools and test equipment required	5-2
Touchup painting instructions	5-7
TRANSMITTER RADIO section controls and connectors	3-11
Troubleshooting information, additional	6-26
Troubleshooting, organizational chart	5-8
TUNER, RADIO FREQ section controls, indicators, and connectors	3-24
Unpacked equipment, checking	2-2
Use and purpose	1-9
Video amplifier section controls, indicators, and connectors	3-30
Voltage regulator 4A1VR1, replacement of	5-29
Voltage regulator amplifier, replacement of	
455-487	5-16
456-381	5-23
Voltage regulator section controls, indicators, and connectors	3-41
26V supply section control, indicator, fuses, and connectors	3-3

By Order of the Secretary of the Army:

Official:

ROBERT M. JOYCE
Major General United States Army
The Adjutant General

E. C. MEYER
General United States Army
Chief of Staff

* U.S. GOVERNMENT PRINTING OFFICE : 1990 0 - 261-872 (20638)

RECOMMENDED CHANGES TO EQUIPMENT TECHNICAL PUBLICATIONS



THEN... JOT DOWN THE DOPE ABOUT IT ON THIS FORM, CAREFULLY TEAR IT OUT, FOLD IT AND DROP IT IN THE MAIL!

SOMETHING WRONG WITH THIS PUBLICATION?

FROM: (PRINT YOUR UNIT'S COMPLETE ADDRESS)

DATE SENT

PUBLICATION NUMBER

PUBLICATION DATE

PUBLICATION TITLE

BE EXACT... PIN-POINT WHERE IT IS

PAGE NO.

PARA-GRAPH

FIGURE NO.

TABLE NO.

IN THIS SPACE TELL WHAT IS WRONG AND WHAT SHOULD BE DONE ABOUT IT:

TEAR ALONG PERFORATED LINE

PRINTED NAME, GRADE OR TITLE, AND TELEPHONE NUMBER

SIGN HERE:

DA FORM 2028-2
1 JUL 79

PREVIOUS EDITIONS ARE OBSOLETE.

P.S.—IF YOUR OUTFIT WANTS TO KNOW ABOUT YOUR RECOMMENDATION MAKE A CARBON COPY OF THIS AND GIVE IT TO YOUR HEADQUARTERS.

PIN: 016142-000